

BWS **BEST WAY**
STONE[®]
 2021 PRODUCT GUIDE

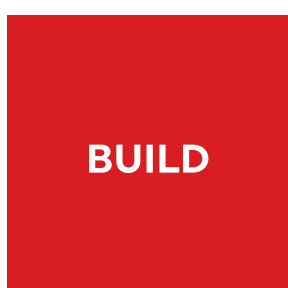

Stone Finder

Every project is different, and we have the right products to suit your style needs.

Visit bestwaystone.com/stonefinder or look for it right on our homepage and find the stone that's right for you.

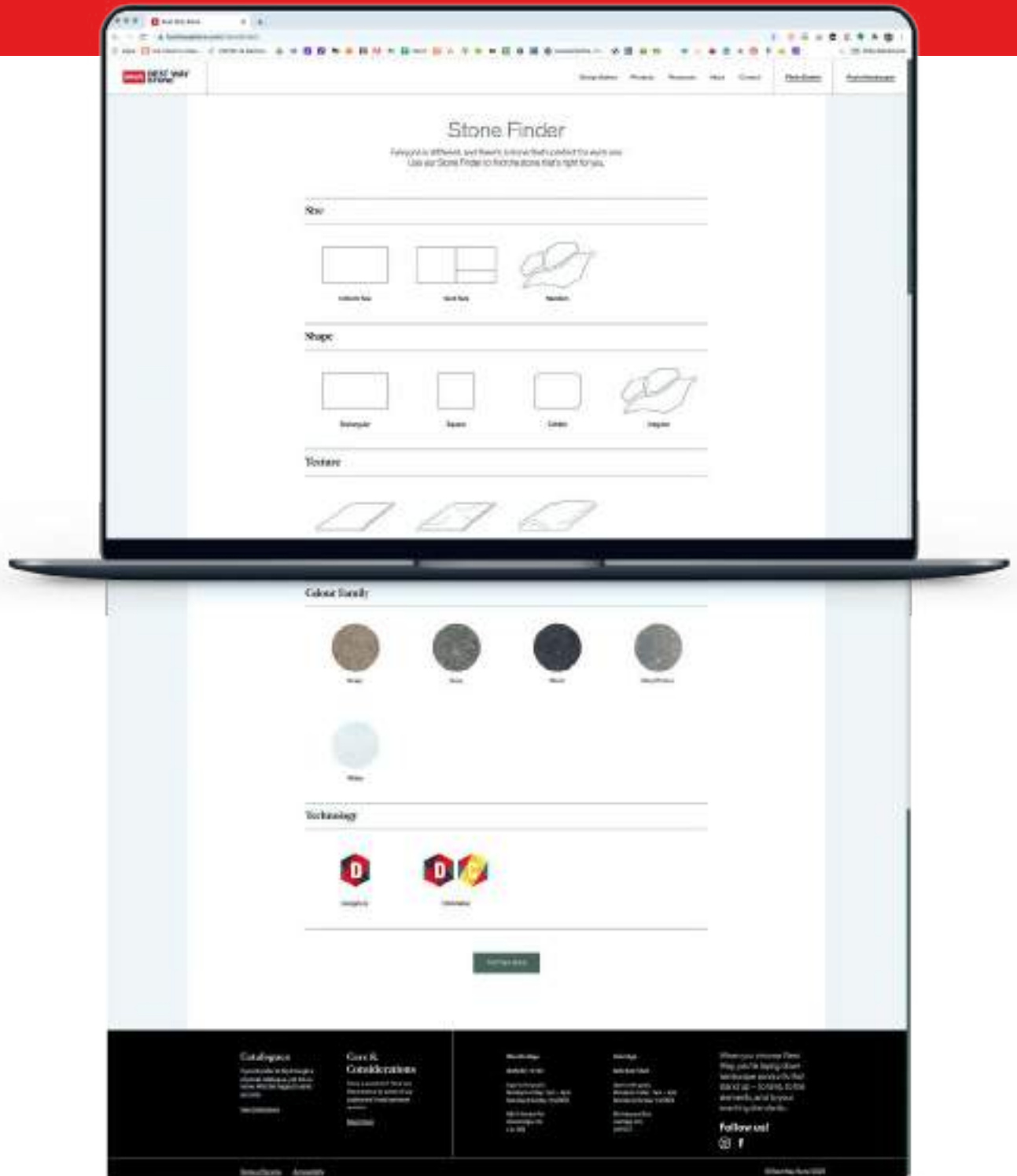

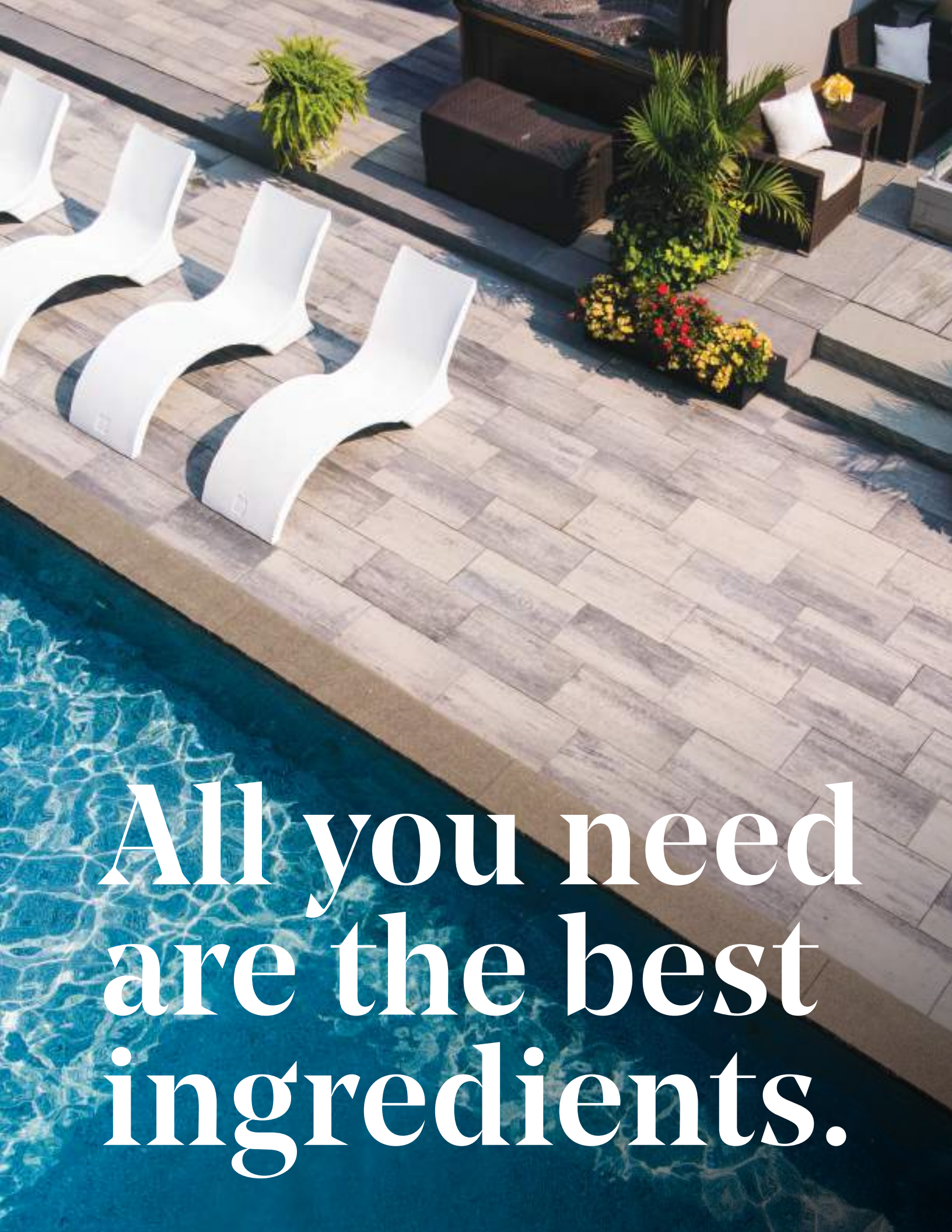

All you need
are the best
ingredients.



Our Dealer Network

Our extended family includes an extensive network of dealers located throughout Ontario, Quebec, and North-East Michigan. Our dealers will help you visualize your landscape by pairing the right products with your project design and style needs.

Visit our website to find a dealer near you:

www.bestwaystone.com/dealers

The best products built using the best practices.

INDEX

PAVERS

- 12 Manhattan Plank
- 13 Trevista® 80 Smooth
- 14 Trevista® 80 Textured
- 15 Richmond® 80
- 16 Adelaide® 80
- 17 Corso®
- 18 Moderna®
- 19 Ardesia®
- 20 Strada® Nova
- 22 Ashford (NEW)
- 23 Belgium
- 24 Standard™
- 25 Double Standard™

SLABS

- 28 Tresca™
- 30 Avari
- 31 Ventura (NEW)
- 32 Balsam
- 33 Opus
- 34 BW300
- 35 Lyra (NEW)
- 36 Trevista® 50 Smooth
- 37 Trevista® 50 Textured
- 38 Richmond® 50
- 39 Adelaide® 50
- 40 Flagstone
- 41 Standard Press™
- 42 Basketweave™
- 43 Dado Ceramica Porcelain

WALLS

- 46 Soho
- 47 Arlington (NEW)
- 48 Ikon
- 49 Hazelton™
- 50 Garden Lock™
- 52 Parkwall®
- 54 Antico® Stacker
- 55 RidgeWall® SRW System
- 58 Rockton
- 59 Belvedere

STEPS, CAPS & CURBS

- 62 Camden Step
- 63 Ikon Step
- 63 Ridge™ Step
- 64 Sopra Coping
- 64 Montana Cap
- 64 Montana Column Cap
- 64 Riviera Cap
- 65 Dimensional Coping
- 65 Barollo® Coping
- 65 Bullnose Column Cap
- 65 Parkwall® Column Cap
- 66 Antico® Curb
- 66 Garden Curb
- 66 Driveway Curbs

ENVIRO

- 70 Moderna® Permeable Paver
- 71 Solar Reflective Rooftop Paver

MASONRY & BUILDER

- 72 Split-Face Window Sills
- 72 Keystone
- 72 Splash Pad
- 72 Step Risers
- 73 Chimney Caps
- 73 Simplicity Steps

ACCESSORIES

- 74 Joint Sand
- 74 Sealers & Cleaners
- 75 Tools & Other Accessories

RESOURCES

- 78 2021 Colour Chart
- 78 Solar Reflectance Index
- 80 Installation Guide - Slabs
- 80 Installation Guide - Slabs on Pedestal Set
- 80 Installation Guide - Pavers
- 81 Installation Guide - Permeable Pavers
- 82 Installation Guide - Walls
- 84 Care & Considerations
- 85 Outdoor Design Centre
- 86 Safety Precautions
- 87 Our Locations

LEGEND



Vehicle use permitted



Permeable and/or
Eco-Friendly product



Pedestrian
traffic only



Vibrating plate permitted
(rubber membrane required)



Made with DesignLoc®



Made with ChromaTec™



Our pavers and slabs are resistant to the elements, exceeding all industry standards, standing up to salt, oil, gas, and chlorine.



Our products are built using two key ingredients: quality and care. All are manufactured to meet and exceed their respective North American standards set by both the CSA and ASTM.



That commitment to quality is backed by our transferable lifetime guarantee on the structural integrity of our pavers. You can learn more about our transferable lifetime guarantee on our website: [bestwaystone.com](https://www.bestwaystone.com)

Designed to last generations.

One of the most common questions we get from customers purchasing hardscape products is how they will wear over time. Our recent technological advancements provide layers of enriched surfaces and colour, bringing product aesthetics and performance to the next level.



The DesignLoc surface refinement technology is a strategic mix design that produces a highly controlled and refined surface offering.



ChromaTec protective surface enhancer adds a level of protection that helps resist the threat of stains from foreign elements while enhancing the vibrancy of the coated surface.



A photograph of an outdoor patio area. In the center is a large, circular fire pit constructed from stacked grey stone blocks. The fire pit has a custom gas insert and an additional row of blocks at the top. Surrounding the fire pit is a wicker outdoor sofa with cream-colored cushions. To the left, there is a wicker chair with a white fringed cover. The patio is paved with grey stone tiles. In the background, there is a wooden fence and some potted plants. The text "OUTDOOR ELEMENTS COLLECTION" is overlaid in large white letters on the lower half of the image.

OUTDOOR ELEMENTS COLLECTION

Outdoor living with ease.

Fire pit shown with a customized gas insert
and additional row of block.



**EASY TO BUILD KITS
ARRIVING 2021**

**FIRE PITS
FIREPLACES
COUNTERS
OVENS
GRILL SURROUNDS
STORAGE
+ MORE**

**EXPLORE OUR GROWING COLLECTION OF
EASY TO BUILD OUTDOOR ELEMENTS AT
[BESTWAYSTONE.COM/OUTDOORELEMENTS](https://bestwaystone.com/outdoorelements)**

New for 2021

Take a look at what's new for the 2021 season. We are constantly pushing the edge of product design, to see all our new products visit www.bestwaystone.com/newproducts

 Made with DesignLoc®

Carrara

Our modern and bold Carrara colour is now available throughout our Opus and Trevista collection of products.





HARBOUR GREY



ULTRA BLACK

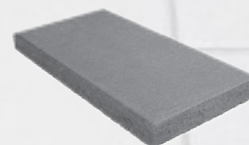

Lyra slab

This 12×24 slab provides both a modern design and a highly detailed surface. Lyra offers a contemporary smooth finish, and is offered in two beautiful colours.



Ventura slab

This family of slabs offers a large format finish with a subtle pop of texture. Ventura will bring a grand elegance to any pool deck, patio or walkway.

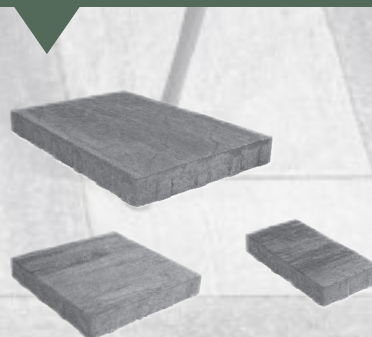

CARRARA



GLACIER CREEK





PAVERS

 Signature Series	mm
12 MANHATTAN PLANK	80
13 TREVISTA® SMOOTH	80
14 TREVISTA® TEXTURED	80
15 RICHMOND®	80
16 ADELAIDE®	80

Classic Series	mm
17 CORSO®	70
 18 MODERNA®	70
19 ARDESIA®	70
20 STRADA® NOVA	70
22 ASHFORD (NEW)	60
23 BELGIUM	60
24 STANDARD™	60
25 DOUBLE STANDARD™	60

PHYSICAL & GEOMETRICAL CHARACTERISTICS PRECAST CONCRETE PAVERS

Characteristics	CSA A231.2
Compressive Strength	50 MPa (7252 psi) min.
Freeze-thaw Durability w/ use of deicing salt	Mass loss (max): 225 g/m ² at 28 cycles Mass loss (max): 500 g/m ² at 49 cycles
Dimensional tolerances ¹	Length and Width: -1.0mm to +2.0mm Thickness: ±3 mm

1. Dimensional tolerances prior to the application of architectural finishes

MANHATTAN PLANK

SIGNATURE SERIES PAVER / 80MM /   



BUNDLE OVERVIEW

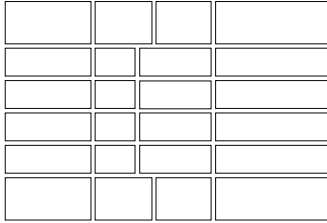

UNITS



A
6.50 x 4.33 x 3.15 in
165 x 110 x 80 mm
Units/bundle: 32
Units/layer: 4



B
10.83 x 4.33 x 3.15 in
275 x 110 x 80 mm
Units/bundle: 32
Units/layer: 4



C
12.99 x 4.33 x 3.15 in
330 x 110 x 80 mm
Units/bundle: 32
Units/layer: 4



D
17.32 x 4.33 x 3.15 in
440 x 110 x 80 mm
Units/bundle: 32
Units/layer: 4



E
8.66 x 6.50 x 3.15 in
220 x 165 x 80 mm
Units/bundle: 32
Units/layer: 4



F
12.99 x 6.50 x 3.15 in
330 x 165 x 80 mm
Units/bundle: 16
Units/layer: 2



G
17.32 x 6.50 x 3.15 in
440 x 165 x 80 mm
Units/bundle: 16
Units/layer: 2

NOTES

Provides a contemporary linear finish. Manhattan Plank is 80mm thick, ideal for any application. Install in a ratio of 2 (4.33") rows to every 1 (6.5") row. All sizes are sold and packaged together. The DesingLoc surface technology provides a highly refined, colour enriched finish.

BUNDLE SPECIFICATIONS

IMPERIAL

METRIC

	IMPERIAL	METRIC
Coverage	80 ft ²	7.44 m ²
Weight	2890 lbs	1311 kg
Layers	8	
Coverage per layer	10 ft ²	0.93 m ²
Lineal coverage (A-D)	127 ft	38.72 m
Lineal coverage per layer (A-D)	15.875 ft	4.84 m
Lineal coverage (E-G)	63.5 ft	19.36 m
Lineal coverage per layer (E - G)	7.94 ft	2.42 m

COLOURS

Glacier Creek
Grey Mix
Ultra Black

PATTERN

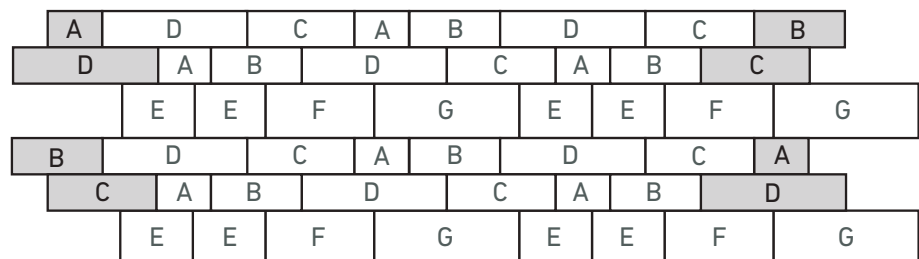

TREVISTA[®] 80 SMOOTH

SIGNATURE SERIES PAVER / 80MM /   



BUNDLE OVERVIEW

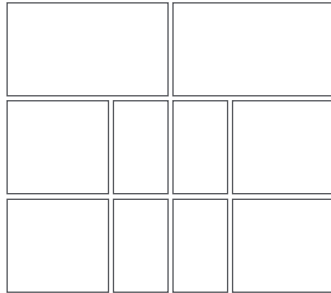

UNITS



19.5 x 13 x 3.15 in
495 x 330 x 80 mm
Units/bundle: 16
Units/layer: 2

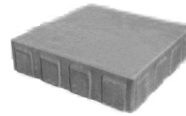

13 x 13 x 3.15 in
330 x 330 x 80 mm
Units/bundle: 32
Units/layer: 4



6.5 x 13 x 3.15 in
165 x 330 x 80 mm
Units/bundle: 32
Units/layer: 4

NOTES

For pedestrian and/or vehicular use. Trevista 80 Smooth is a large format paver with a smooth modern surface. Sold and packaged together in a 1:2:2 ratio. The DesignLoc surface technology provides a highly refined, colour enriched finish.

BUNDLE SPECIFICATIONS

	IMPERIAL	METRIC
Coverage	83.6 ft ²	7.76 m ²
Weight	3077 lbs	1395.85 kg
Layers	8	
Coverage per layer	10.45 ft ²	0.97 m ²
Lineal coverage	78 ft / 52 ft	23.77 m / 15.85 m
Lineal coverage per layer	9.75 ft / 6.5 ft	2.97 m / 1.98 m

COLOURS

Beige Mix
Carrara (NEW)
Driftwood
Glacier Creek
Grey Mix

PATTERNS

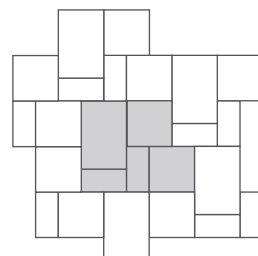
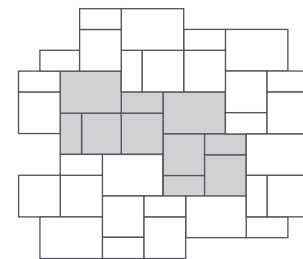
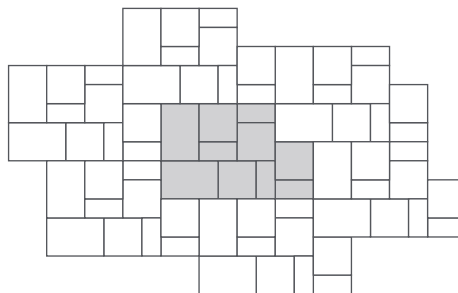

13" Soldier Course



19.5" Soldier Course

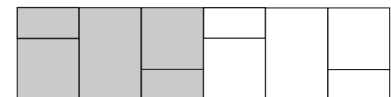

TREVISTA® 80 TEXTURED



SIGNATURE SERIES PAVER / 80MM /   

BUNDLE OVERVIEW

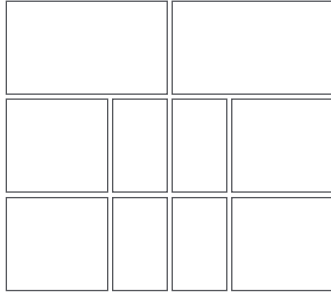

UNIT



19.5 x 13 x 3.15 in
495 x 330 x 80 mm
Units/bundle: 16
Units/layer: 2



13 x 13 x 3.15 in
330 x 330 x 80 mm
Units/bundle: 32
Units/layer: 4



6.5 x 13 x 3.15 in
165 x 330 x 80 mm
Units/bundle: 32
Units/layer: 4

NOTES

For pedestrian and/or vehicular use. Trevista 80 Textured is a large format paver with an elegant and traditional texture. Sold and packaged together in a 1:2:2 ratio. The DesignLoc surface technology provides a highly refined, colour enriched finish.

BUNDLE SPECIFICATIONS

IMPERIAL

METRIC

	IMPERIAL	METRIC
Coverage	83.6 ft ²	7.76 m ²
Weight	3077 lbs	1395.85 kg
Layers	8	
Coverage per layer	10.45 ft ²	0.97 m ²
Lineal coverage	78 ft / 52 ft	23.77 m / 15.85 m
Lineal coverage per layer	9.75 ft / 6.5 ft	2.97 m / 1.98 m

COLOURS

Beige Mix
Carrara (NEW)
Driftwood
Glacier Creek
Grey Mix

PATTERNS

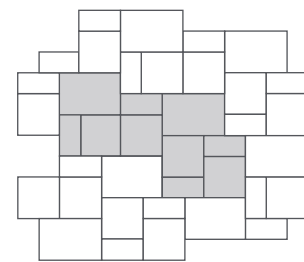
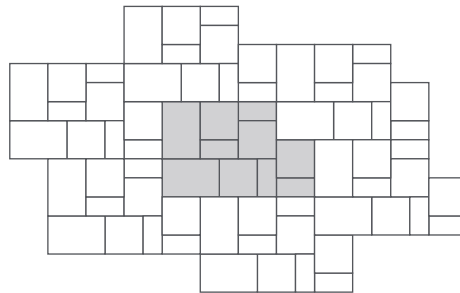

13" Soldier Course



19.5" Soldier Course

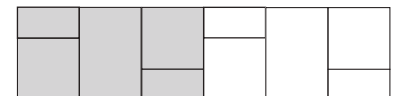

RICHMOND® 80

SIGNATURE SERIES PAVER / 80MM /   



BUNDLE OVERVIEW



UNIT



6.5 x 13 x 3.15 in
165 x 330 x 80 mm
Units/bundle: 168
Units/layer: 21

NOTES

For pedestrian and/or vehicular usage. Can be used on its own, or as an accent and/or border for the Trevista® 80 pavers. Subtle textured surface provides striking interest.

BUNDLE SPECIFICATIONS

IMPERIAL

METRIC

	IMPERIAL	METRIC
Coverage	98.4 ft ²	9.1 m ²
Weight	3622 lbs	1643 kg
Layers	8	
Coverage per layer	12.3 ft ²	1.14 m ²
Lineal coverage	91 ft / 182 ft	27.7 m / 55.4 m
Lineal coverage per layer	11.38 ft / 22.75 ft	3.47 m / 6.93 m

COLOURS

Beige Mix
Glacier Creek
Grey Mix
Ultra Black

PATTERNS

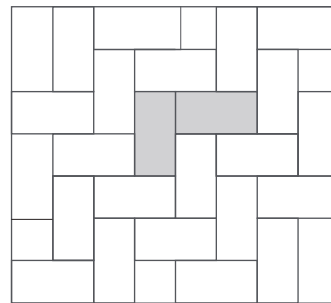
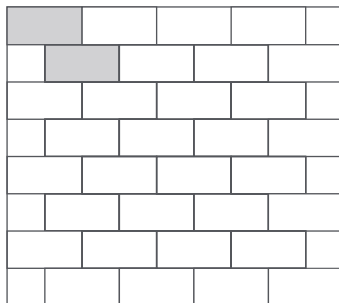

ADELAIDE[®] 80

SIGNATURE SERIES PAVER / 80MM /   



BUNDLE OVERVIEW



UNIT



6.5 x 13 x 3.15 in
165 x 330 x 80 mm
Units/bundle: 168
Units/layer: 21

NOTES

For pedestrian and/or vehicular usage. Can be used on its own or as a modern accent and/or border for the Trevista[®] 80 pavers. The smooth surface provides a contemporary finish.

BUNDLE SPECIFICATIONS

IMPERIAL

METRIC

	IMPERIAL	METRIC
Coverage	98.4 ft ²	9.1 m ²
Weight	3622 lbs	1643 kg
Layers	8	
Coverage per layer	12.3 ft ²	1.14 m ²
Lineal coverage	91 ft / 182 ft	27.7 m / 55.4 m
Lineal coverage per layer	11.38 ft / 22.75 ft	3.47 m / 6.93 m

COLOURS

Glacier Creek
Grey
Ultra Black

PATTERNS

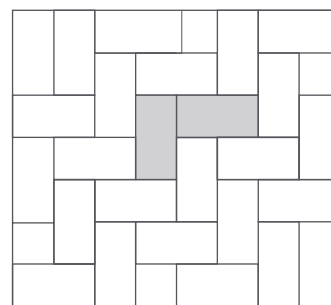
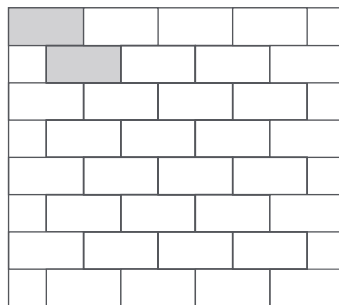

CORSO®

CLASSIC SERIES PAVER / 70MM /  



BUNDLE OVERVIEW

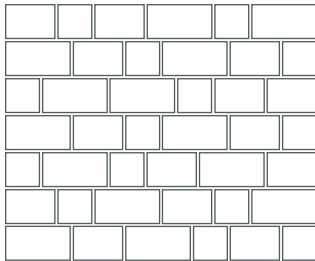

UNIT



9.96 x 5.24 x 2.75 in
253 x 133 x 70 mm
Units/bundle: 112
Units/layer: 14



7.60 x 5.24 x 2.75 in
193 x 133 x 70 mm
Units/bundle: 112
Units/layer: 14



5.24 x 5.24 x 2.75 in
133 x 133 x 70 mm
Units/bundle: 112
Units/layer: 14

NOTES

For pedestrian and/or vehicular use. Corso provides a European cobblestone aesthetic with a highly detailed texture. All sizes are sold and packaged together in a 1:1:1 ratio.

BUNDLE SPECIFICATIONS

IMPERIAL

METRIC

Coverage	94 ft ²	8.74 m ²
Weight	2907 lbs	1318.78 kg
Layers	8	
Coverage per layer	11.75 ft ²	1.09 m ²
Lineal coverage	212.8 ft	64.85 m
Lineal coverage per layer	26.6 ft	8.11 m

COLOURS

Grey Mix
Ultra Black

PATTERN

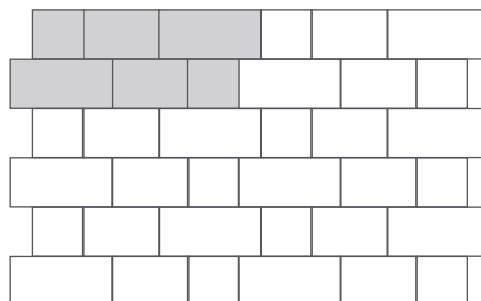

MODERNA®

CLASSIC SERIES PAVER / 70MM /   



BUNDLE OVERVIEW

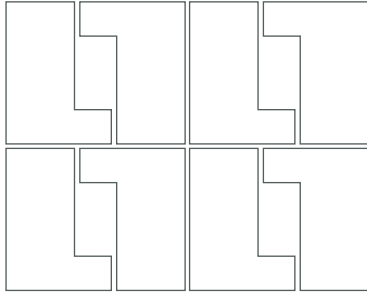

UNITS

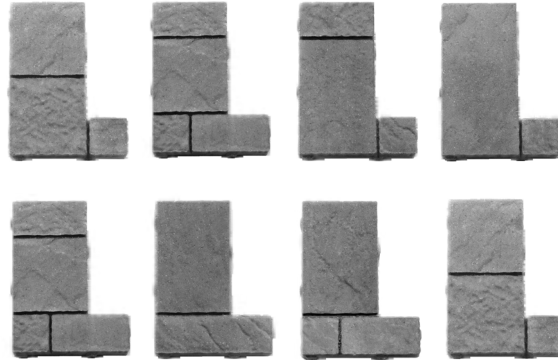

16 x 8/12 x 2.75 in
405 x 205/305 x 70 mm
Units/bundle: 64
Units/layer: 8

NOTES

For pedestrian and/or vehicular use. Install by layer for most random finish. Single shape false joint paver allows for easy and quick installation. Moderna can also be installed as a permeable paver.

BUNDLE SPECIFICATIONS

IMPERIAL

METRIC

	IMPERIAL	METRIC
Coverage	62 ft ²	5.76 m ²
Weight	1918 lbs	869.84 kg
Layers	8	
Coverage per layer	7.75 ft ²	0.72 m ²
Lineal coverage	47 ft*	14.4 m*
Lineal coverage per layer	5.875 ft*	1.8 m*

COLOURS

Beige Mix
Grey Mix

PATTERNS

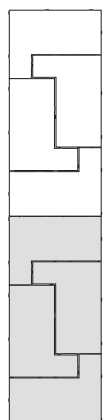
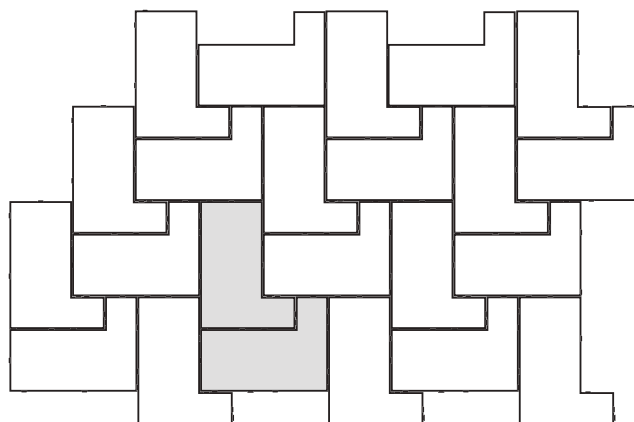

*16" SOLDIER COURSE

ARDESIA®

CLASSIC SERIES PAVER / 70MM /  



BUNDLE OVERVIEW

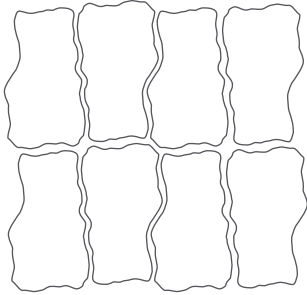

UNITS

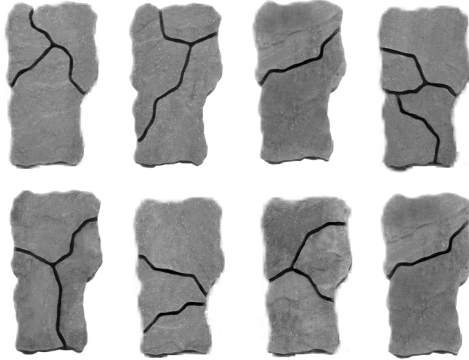

19.29 x 10.41 x 2.75 in
490 x 265 x 70 mm
Units/bundle: 64
Units/layer: 8

NOTES

For pedestrian and/or vehicular use. Single shape false joint paver allows for easy and quick installation. The Flagstone surface design provides a natural finish.

BUNDLE SPECIFICATIONS

IMPERIAL

METRIC

	IMPERIAL	METRIC
Coverage	76.2 ft ²	7.08 m ²
Weight	2357 lbs	1069.06 kg
Layers	8	
Coverage per layer	9.52 ft ²	0.88 m ²
Lineal coverage	-	-
Lineal coverage per layer	-	-

COLOURS

Beige Mix
Grey Mix

PATTERN

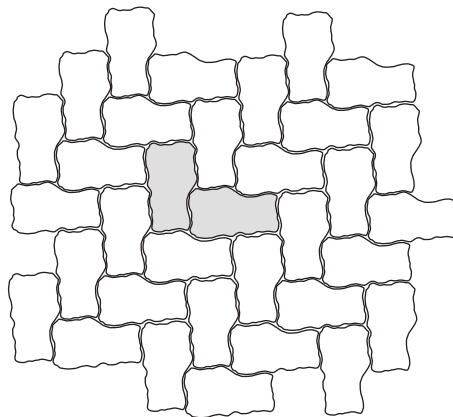

STRADA[®] NOVA

CLASSIC SERIES PAVER / 70MM /  

UNITS



JUMBO
10.28 x 13.78 x 2.75 in
261 x 350 x 70 mm
Units/bundle: 72
Units/row: 9



LARGE
8.19 x 6.88 x 2.75 in
208 x 175 x 70 mm
Units/bundle: 200
Units/row: 25



MEDIUM
6.14 x 6.88 x 2.75 in
156 x 175 x 70 mm
Units/bundle: 280
Units/row: 35



SMALL
4.13 x 6.88 x 2.75 in
103 x 175 x 70 mm
Units/bundle: 384
Units/row: 48

BUNDLE SPECIFICATIONS

IMPERIAL

METRIC

Coverage	72 ft ²	6.6 m ²
Weight	2227 lbs	1010.13 kg
Rows*	8	
Coverage per row*	9 ft ²	0.82 m ²
Lineal coverage	61.68 ft / 82.68 ft	18.8 m / 25.2 m
Lineal coverage per row*	7.71 ft / 10.34 ft	2.35 m / 3.15 m
Coverage per unit	1 ft ²	0.093 / m ²
Units per ft ² / m ²	1	10.91

Coverage	80 ft ²	7.43 m ²
Weight	2474 lbs	1122.37 kg
Rows*	8	
Coverage per row*	10 ft ²	0.93 m ²
Lineal coverage	115 ft / 136.5 ft	35.05 m / 41.6 m
Lineal coverage per row*	14.37 ft / 17.06 ft	4.38 m / 5.2 m
Coverage per unit	0.4 ft ²	0.037 m ²
Units per ft ² / m ²	2.5	26.92

Coverage	84 ft ²	7.8 m ²
Weight	2598 lbs	1178.49 kg
Rows*	8	
Coverage per row*	10.5 ft ²	0.97 m ²
Lineal coverage	147 ft / 160.5 ft	44.8 m / 48.9 m
Lineal coverage per row*	18.37 ft / 20.1 ft	5.6 m / 6.1 m
Coverage per unit	0.3 ft ²	0.028 m ²
Units per ft ² / m ²	3.33	35.9

Coverage	78 ft ²	7.24 m ²
Weight	2413 lbs	1094.31 kg
Rows*	8	
Coverage per row*	9.75 ft ²	0.9 m ²
Lineal coverage	129.75 ft / 220.2 ft	39.55 m / 67.2 m
Lineal coverage per row*	16.2 ft / 27.5 ft	4.94 m / 8.4 m
Coverage per unit	0.2 ft ²	0.019 / m ²
Units per ft ² / m ²	4.9	53.04



NOTES

For pedestrian and/or vehicular use.
Multiple size paver with antiqued surface treatment. Each size is sold and packaged separately.

*Sold in full bundles only.

BUNDLE OVERVIEW

JUMBO



MEDIUM

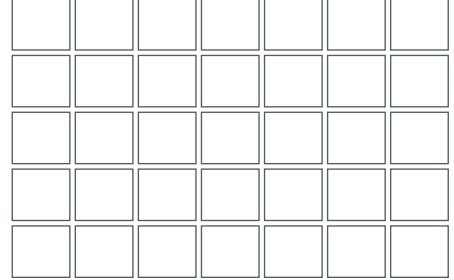

LARGE

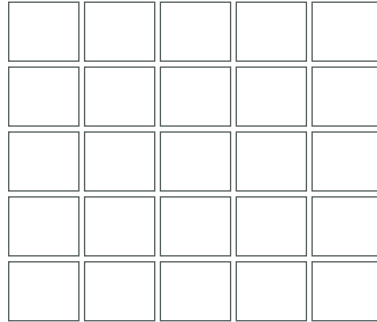

SMALL

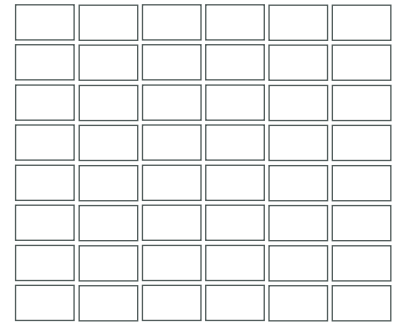

COLOURS

Beige Mix
Grey Mix
Ultra Black (Unavailable in medium)

PATTERNS

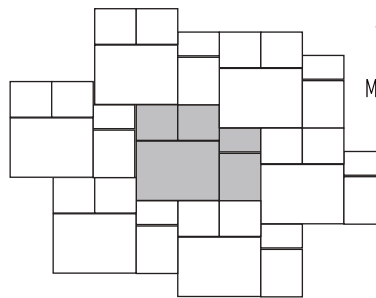

Jumbo - 46%
Large - 18%
Medium - 27%
Small - 9%

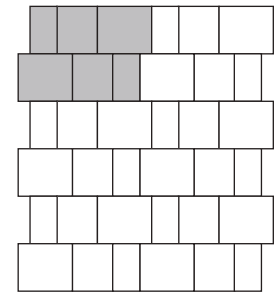

Large - 44%
Medium - 33%
Small - 23%

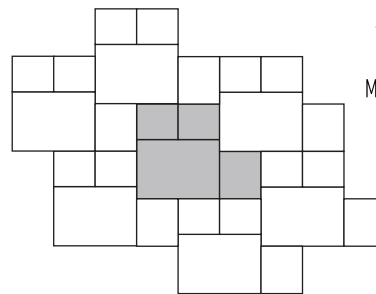

Jumbo - 50%
Large - 20%
Medium - 30%

CLASSIC SERIES PAVER / 60MM /  

BUNDLE OVERVIEW

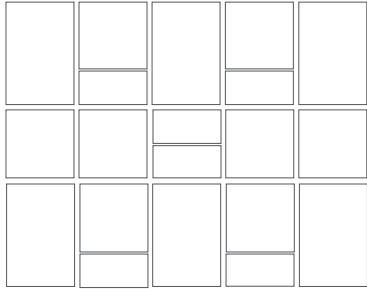

UNITS



13 x 8.66 x 2.36 in
330 x 220 x 60 mm
Units/bundle: 54
Units/layer: 6

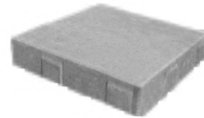

8.66 x 8.66 x 2.36 in
220 x 220 x 60 mm
Units/bundle: 72
Units/layer: 8



8.66 x 4.33 x 2.36 in
220 x 110 x 60 mm
Units/bundle: 54
Units/layer: 6

NOTES

For pedestrian and/or vehicular use with a smooth modern surface finish. Sold and packaged together in a 3:4:3 ratio. Pair with Belgium paver as border or accent option.

BUNDLE SPECIFICATIONS

IMPERIAL

METRIC

	IMPERIAL	METRIC
Coverage	93.75 ft ²	8.71 m ²
Weight	2812 lbs	1156 kg
Layers	9	
Coverage per layer	10.42 ft ²	0.97 m ²
Lineal coverage	130 ft	39.6 m
Lineal coverage per layer	14.44 ft	4.4 m

COLOURS

Harbour Grey (NEW)
Winterborn

PATTERNS

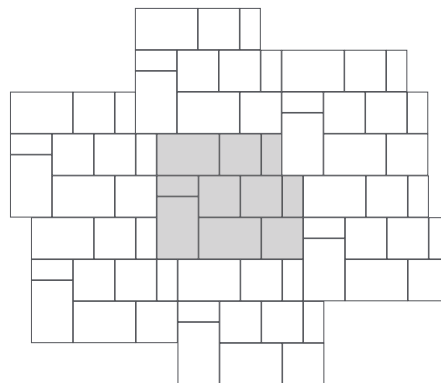

8.66" Soldier Course

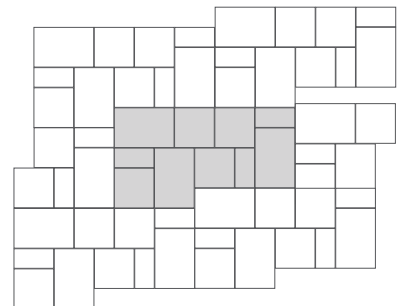

13" Soldier Course

BELGIUM

CLASSIC SERIES PAVER / 60MM /  



BUNDLE OVERVIEW

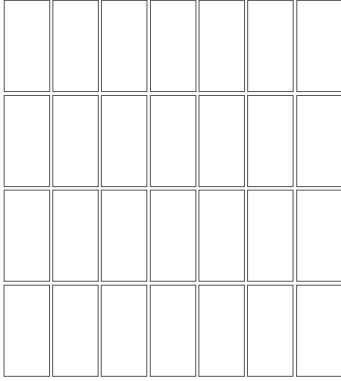

UNIT



5.9 x 11.8 x 2.36 in
 150 x 300 x 60 mm
 Units/bundle: 252
 Units/section: 63

NOTES

For pedestrian and/or vehicular use with a slightly textured finish. Can be used on its own or provides a border option for the Ashford, Balsam, Opus or Ventura.

BUNDLE SPECIFICATIONS

IMPERIAL

METRIC

	IMPERIAL	METRIC
Coverage	124 ft ²	11.52 m ²
Weight	3410 lbs	1536 kg
Sections	4	
Coverage per section	31 ft ²	2.88 m ²
Lineal coverage	123.9 ft / 61.9 ft	37.76 m / 18.86 m
Lineal coverage per section	31 ft / 15.5 ft	9.45 m / 4.72 m

COLOURS

Charcoal

PATTERNS

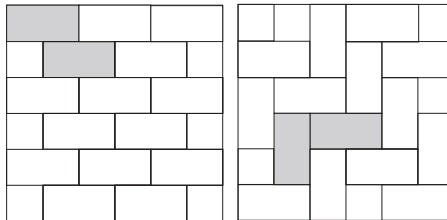

STANDARD

CLASSIC SERIES PAVER / 60MM /  



BUNDLE OVERVIEW

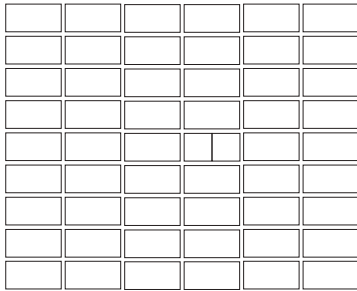

UNIT



3.93" x 7.87" x 2.36"
 100mm x 200mm x 60mm
 Units/bundle: Full 477 / Half 18
 Units/row*: Full 53 / Half 2

NOTES

For pedestrian and/or vehicular use. Provides a classic smooth surface with subtle edges.

*Sold in full bundles only.

BUNDLE SPECIFICATIONS

IMPERIAL

METRIC

	IMPERIAL	METRIC
Coverage	106 ft ²	9.85 m ²
Weight	2862 lbs	1298.18 kg
Rows*	9	
Coverage per row*	11.78 ft ²	1.09 m ²
Lineal coverage	156.2 ft / 312.8 ft	47.7 m / 95.4 m
Lineal coverage per row*	17.35 ft / 34.75 ft	5.3 m / 10.6 m
Coverage per unit*	0.22 ft ²	0.02 m ²
Units per ft ² / m ²	4.59	49.34

COLOURS

- Buff Mix
- Buff-Brown Mix
- Charcoal
- Grey
- Grey Mix
- Red
- Red Mix
- Salmon Mix

PATTERNS

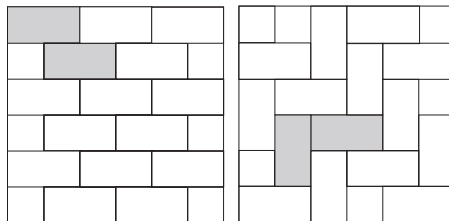

DOUBLE STANDARD

CLASSIC SERIES PAVER / 60MM /  



BUNDLE OVERVIEW

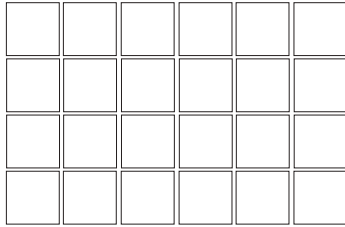

UNIT



7.87" x 7.87" x 2.36"
 200mm x 200mm x 60mm
 Units/bundle: 216
 Units/row: 24

NOTES

For pedestrian and/or vehicular use. Provides a smooth square surface with subtle edges.

*Sold in full bundles only.

BUNDLE SPECIFICATIONS

IMPERIAL

METRIC

	IMPERIAL	METRIC
Coverage	94 ft ²	8.73 m ²
Weight	2538 lbs	1151.22 kg
Rows	9	
Coverage per row	10.44 ft ²	0.97 m ²
Lineal coverage	144 ft	43.9 m
Lineal coverage per row	16 ft	4.88 m
Coverage per unit	0.44 ft ²	0.04 m ²
Units per ft ² / m ²	2.3	24.74

COLOURS

- Charcoal
- Grey
- Grey Mix
- Red
- Red Mix
- Salmon Mix

PATTERNS

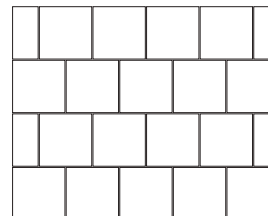
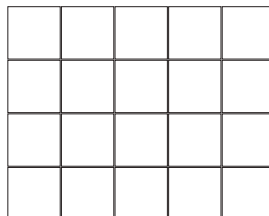



SLABS

Enhanced Series **mm**

28	TRESCA™	50
30	AVARI	50

Signature Series **mm**

31	VENTURA (NEW)	60
32	BALSAM	60
33	OPUS	60
34	BW300	60
35	LYRA (NEW)	50
36	TREVISTA® SMOOTH	50
37	TREVISTA® TEXTURED	50
38	RICHMOND	50
39	ADELAIDE	50

Classic Series **mm**

40	FLAGSTONE	45
41	STANDARD™ PRESS	45
42	BASKETWEAVE™	45

Porcelain **mm**



43	DADO CERAMICA	20
----	---------------	----

PHYSICAL & GEOMETRICAL CHARACTERISTICS Precast Concrete Paving Slabs

Characteristics	CSA A231.1
Flexural Strength	5.0 MPa (725 psi) min.
Freeze-thaw durability with use of deicing salt	Mass loss (max): 225 g/m ² at 28 cycles Mass loss (max): 500 g/m ² at 49 cycles
Dimensional tolerance ¹	Length and Width: -1.0mm to +2.0mm Thickness: ±3 mm
Concave or Convex Warpage (Over and including 450 mm)	±2.0 mm
Concave or Convex Warpage (Over 450 mm)	±3.0 mm

¹ Dimensional tolerance prior to the application of architectural finishes

TRESCA™

ENHANCED SERIES SLAB / 50MM /  

UNITS



20x20
19.69 x 19.69 x 2 in
500 x 500 x 50 mm
Units/bundle: 40



10x20
9.84 x 19.69 x 2 in
250 x 500 x 50 mm
Units/bundle: 60



10x10
9.84 x 9.84 x 2 in
250 x 250 x 50 mm
Units/bundle: 120

BUNDLE SPECIFICATIONS

IMPERIAL

METRIC

Coverage	107.7 ft ²	10 m ²
Weight	2339 lbs	1060.86 kg
Weight per unit	58.5 lbs	26.52 kg
Coverage per unit	2.69 ft ²	0.25 m ²
Lineal coverage	65.62 ft	20 m
Lineal coverage per unit	1.64 ft	0.5 m
Coverage	80.7 ft ²	7.5 m ²
Weight	1794 lbs	813.74 kg
Weight per unit	29.9 lbs	13.56 kg
Coverage per unit	1.35 ft ²	0.125 m ²
Lineal coverage	49.21ft / 98.42 ft	15 m / 30 m
Lineal coverage per unit	0.82 ft / 1.64 ft	0.25 m / 0.5 m
Coverage	80.7 ft ²	7.5 m ²
Weight	1840 lbs	834.43 kg
Weight per unit	15.4 lbs	6.95 kg
Coverage per unit	0.67 ft ²	0.0625 m ²
Lineal coverage	98.42 ft	30 m
Lineal coverage per unit	0.82 ft	0.25 m



NOTES

For pedestrian use only. The subtle surface texture provides an ideal application for patios and pool decks. DesignLoc technology provides a highly refined finish, protected and enhanced by ChromaTec. Accent or border with Richmond 50 or Adelaide 50.

All sizes sold and packaged separately.
Plate tamper not recommended.

BUNDLE OVERVIEW

20x20

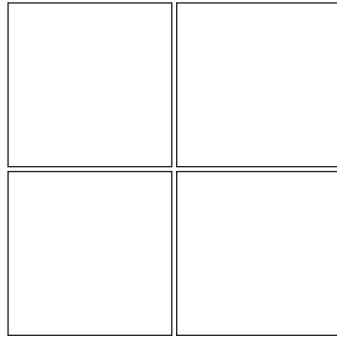

10x10

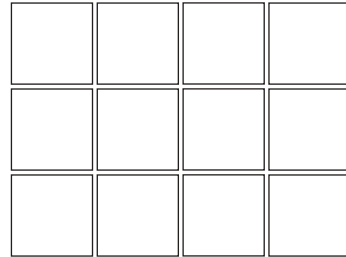

10x20

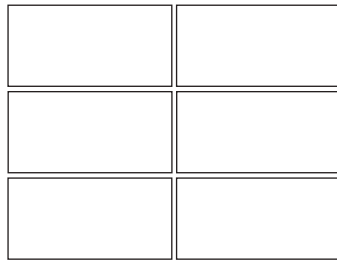

COLOURS

Driftwood
Glacier Creek
Grey Mix

PATTERNS

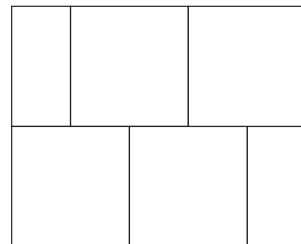
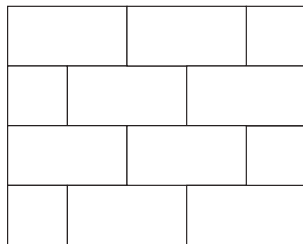
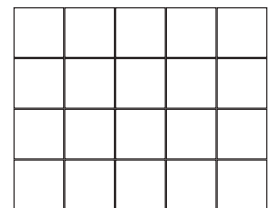
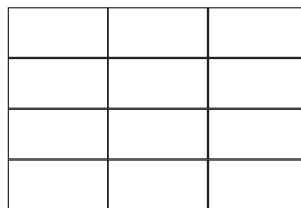
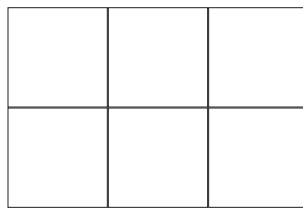

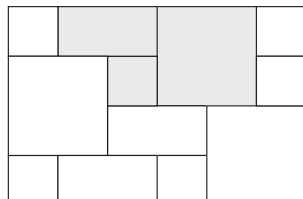

1/2 Off-Set



20x20 - 57%
10x20 - 29%
10x10 - 14%

AVARI

ENHANCED SERIES SLAB / 50MM /   



BUNDLE OVERVIEW

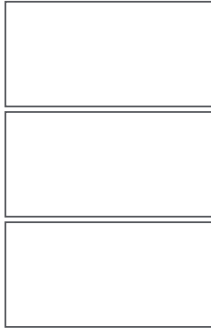

UNIT

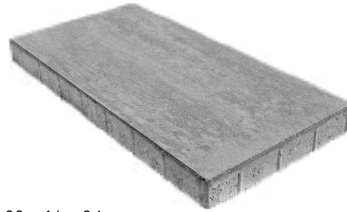

28 x 14 x 2 in
710 x 355 x 50 mm
Units/bundle: 30
Units/layer: 3

NOTES

For pedestrian use only. Large format rectangular slab with soft touch surface. Provides a contemporary smooth finish. DesignLoc technology provides a highly refined finish, protected and enhanced by ChromaTec. Accent or border with Richmond 50 or Adelaide 50.

Plate tamper not recommended.

BUNDLE SPECIFICATIONS

IMPERIAL

METRIC

	IMPERIAL	METRIC
Coverage	81.6 ft ²	7.58 m ²
Weight	1890 lbs	857 kg
Layers	10	
Coverage per layer	8.16 ft ²	0.76 m ²
Lineal coverage	70 ft / 35 ft	21.3 m / 10.7 m
Lineal coverage per layer	7 ft / 3.5 ft	2.13 m / 1.07 m

COLOURS

Carrara
Driftwood
Glacier Creek
Grey Mix
Ultra Black

PATTERNS

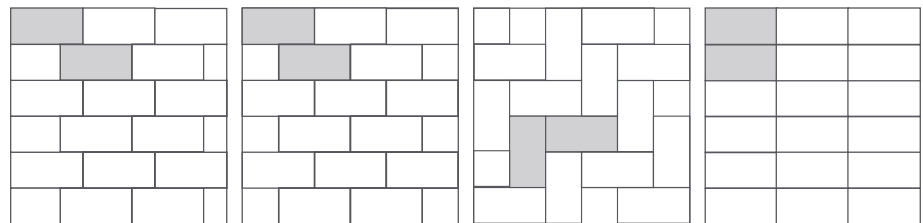

3/4 Off-Set *Best Practice*

1/2 Off-Set

Herringbone

Tile Joint

VENTURA NEW

SIGNATURE SERIES SLAB / 60MM /  



BUNDLE OVERVIEW

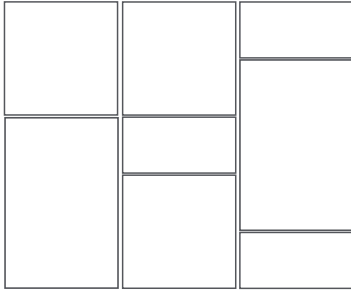

UNITS



24 x 16 x 2.36 in
600 x 400 x 60 mm
Units/bundle: 18
Units/layer: 2



16 x 16 x 2.36 in
400 x 400 x 60 mm
Units/bundle: 27
Units/layer: 3

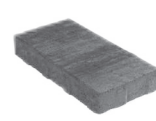

8 x 16 x 2.36 in
200 x 400 x 60 mm
Units/bundle: 27
Units/layer: 3

NOTES

Large format slab with subtle textured surface for pedestrian use only. DesignLoc technology provides a highly refined finish, with integral colouring. Border or accent with Balsam or Belgium.

Sold and packaged together in a 2:3:3 ratio. Plate tamper not recommended.

BUNDLE SPECIFICATIONS

IMPERIAL

METRIC

	IMPERIAL	METRIC
Coverage	116.2 ft ²	10.8 m ²
Weight	3486 lbs	1581 kg
Layers	9	
Coverage per layer	12.9 ft ²	1.2 m ²
Lineal coverage	88.6 ft	27 m
Lineal coverage per layer	9.84 ft	3 m

COLOURS

Carrara
Glacier Creek

PATTERNS

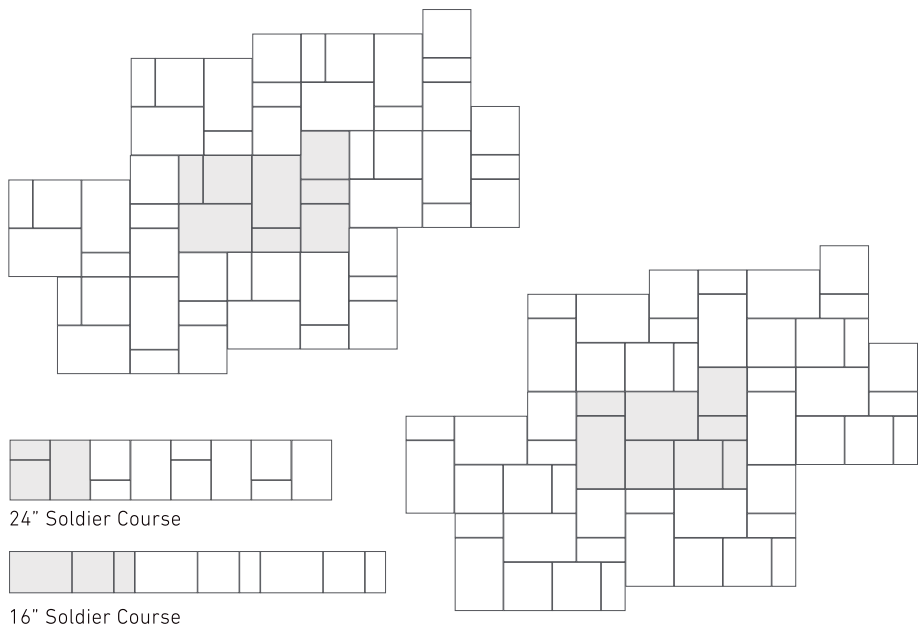

BALSAM

SIGNATURE SERIES SLAB / 60MM /  



BUNDLE OVERVIEW



UNIT



31.5 x 7.87 x 2.36 in
800 x 200 x 60 mm
Units/bundle: 50
Units/layer: 5

NOTES

For pedestrian use only. Elongated plank format slab with wood grain finish. DesignLoc technology provides a highly refined and detailed finish, with integral colouring.

Plate tamper not recommended.

BUNDLE SPECIFICATIONS

IMPERIAL

METRIC

	IMPERIAL	METRIC
Coverage	86 ft ²	8 m ²
Weight	2494 lbs	1131 kg
Layers	10	
Coverage per layer	8.6 ft ²	0.8 m ²
Lineal coverage	131.25 ft / 32.8 ft	40 m / 10 m
Lineal coverage per layer	13.1 ft / 3.28 ft	4 m / 1 m

COLOURS

Glacier Creek
Muskoka
Silver Birch

PATTERNS

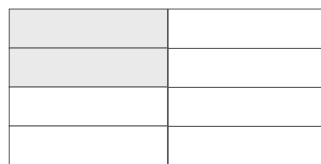

Tile Joint

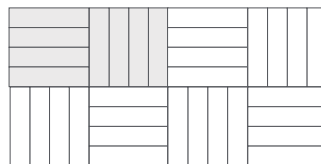

Parquet

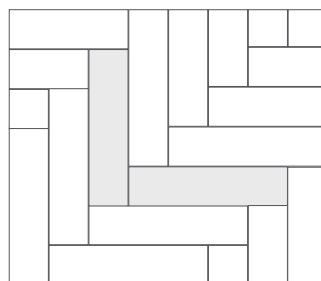

Herringbone

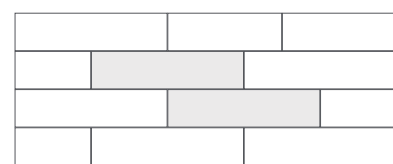

1/2 Off-Set

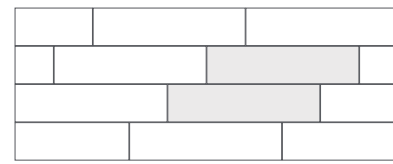

3/4 Off-Set

OPUS

SIGNATURE SERIES SLAB / 60MM /  



BUNDLE OVERVIEW

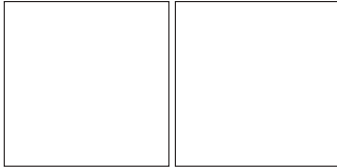

UNIT



23.62 x 23.62 x 2.36 in
600 x 600 x 60 mm
Units/bundle: 18

NOTES

For pedestrian use only. Large format square slab with modern smooth finish. DesignLoc technology provides a highly refined finish, with integral colouring. Can border or accent with Ashford, Balsam, Belgium, or BW300.

Plate tamper not recommended.

BUNDLE SPECIFICATIONS

IMPERIAL

METRIC

	IMPERIAL	METRIC
Coverage	69.7 ft ²	6.47 m ²
Weight	2091 lbs	948.5 kg
Layers	9	
Coverage per layer	7.75 ft ²	0.72 m ²
Lineal coverage	35.4 ft	10.79 m
Lineal coverage per layer	3.94 ft	1.2 m

COLOURS

Carrara (NEW)
Harbour Grey (NEW)
Pearl
Ultra Black

PATTERNS

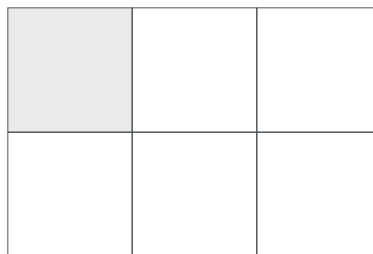

Tile Joint

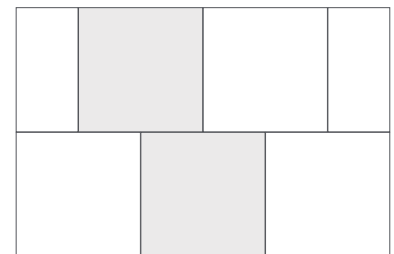

1/2 Off-Set

BW300

SIGNATURE SERIES SLAB / 60MM / 



BUNDLE OVERVIEW

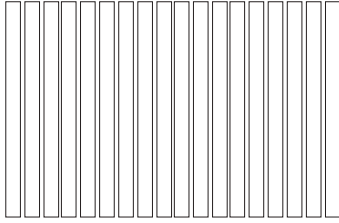

UNIT

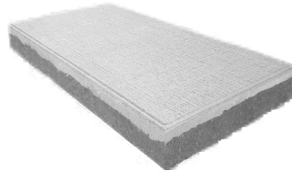

11.81 x 23.62 x 2.36 in
300 x 600 x 60 mm
Units/bundle: 18

NOTES

For pedestrian use only. Contemporary rectangular slab with highly detailed cross-stitch texturing. Can accent or border with Ashford, Balsam, Belgium or Opus.

BW300 does not include spacer bars. Plate tamper not recommended.

BUNDLE SPECIFICATIONS

IMPERIAL

METRIC

	IMPERIAL	METRIC
Coverage	34.8 ft ²	3.23 m ²
Weight	1010 lbs	458 kg
Units	18	
Coverage per unit	1.93 ft ²	0.18 m ²
Lineal coverage	35.4 ft / 17.7 ft	10.79 m / 5.4 m
Lineal coverage per unit	1.97 ft / 0.98 ft	0.6 m / 0.3 m

COLOURS

Nightfall
Pearl
Phantom

PATTERNS

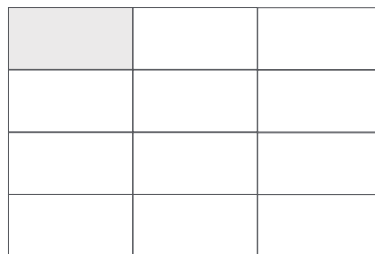

Tile Joint

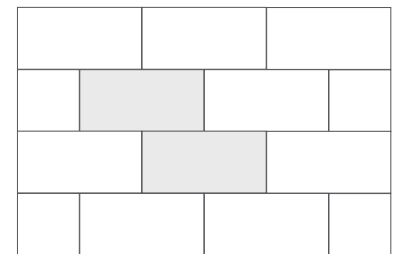

1/2 Off-Set

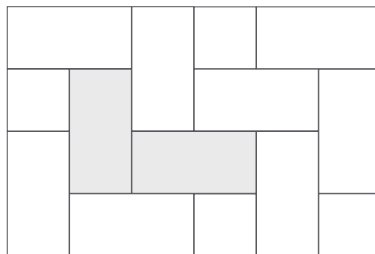

Herringbone

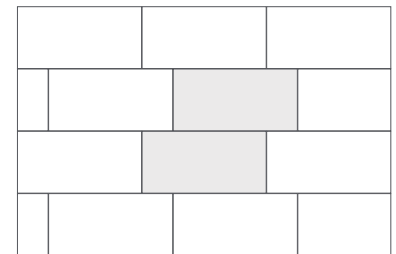

3/4 Off-Set



BUNDLE OVERVIEW



UNIT



11.81 x 23.62 x 2 in
 300 x 600 x 50mm
 Units/bundle: 60
 Units/layer: 6

NOTES

For pedestrian use only. Medium format slab with a soft touch surface. Provides a contemporary finish. DesignLoc technology allows for a highly refined surface, with integral colouring.

Plate tamper not recommended.

BUNDLE SPECIFICATIONS

IMPERIAL

METRIC

	IMPERIAL	METRIC
Coverage	116.3 ft ²	10.8 m ²
Weight	2789 lbs	1265 kg
Layers	10	
Coverage per layer	11.63 ft ²	1.08 m ²
Lineal coverage	118.1 ft / 59.05 ft	18 m / 36 m
Lineal coverage per layer	11.81 ft / 5.9 ft	1.8 m / 3.6 m

COLOURS

Harbour Grey
 Ultra Black

PATTERNS

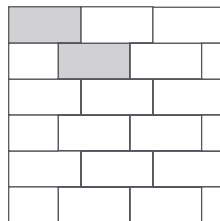

3/4 Off-Set *Best Practice*

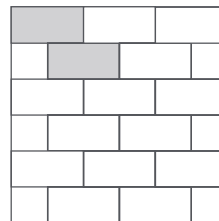

1/2 Off-Set

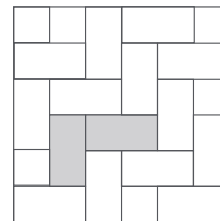

Herringbone

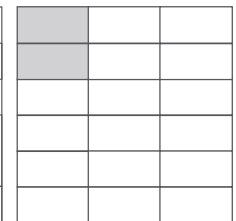

Tile Joint

TREVISTA® 50 SMOOTH

SIGNATURE SERIES SLAB / 50MM /  



BUNDLE OVERVIEW

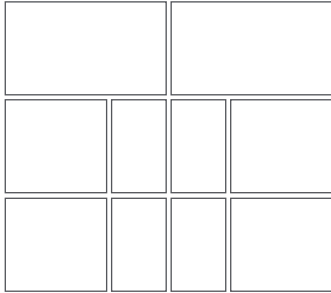

UNITS



19.5 x 13 x 2 in
495 x 330 x 50 mm
Units/bundle: 24
Units/layer: 2



13 x 13 x 2 in
330 x 330 x 50 mm
Units/bundle: 48
Units/layer: 4



6.5 x 13 x 2 in
165 x 330 x 50 mm
Units/bundle: 48
Units/layer: 4

NOTES

For pedestrian use only. Large format slabs with a smooth modern finish. DesignLoc technology provides a highly refined surface, with integral colouring. Border or accent with Adelaide 50, Lyra, Richmond 50 or Tresca.

Sold and packaged together in a 1:2:2 ratio. Plate tamper not recommended.

BUNDLE SPECIFICATIONS

IMPERIAL

METRIC

	IMPERIAL	METRIC
Coverage	125.4 ft ²	11.64 m ²
Weight	3010 lbs	1365 kg
Layers	12	
Coverage per layer	10.45 ft ²	0.97 m ²
Lineal coverage	117 ft / 78 ft	35.64 m / 23.76 m
Lineal coverage per layer	9.75 ft / 6.5 ft	2.97 m / 1.98 m

COLOURS

Beige Mix
Carrara (NEW)
Driftwood
Glacier Creek
Grey Mix

PATTERNS

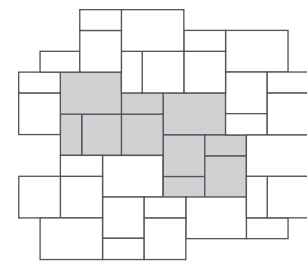
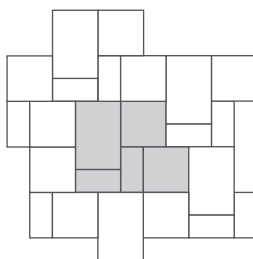
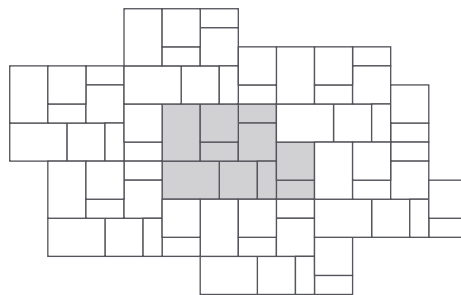

13" Soldier Course



19.5" Soldier Course

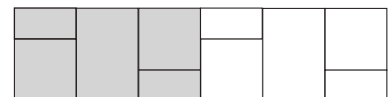

TREVISTA® 50 TEXTURED

SIGNATURE SERIES SLAB / 50MM /  



BUNDLE OVERVIEW

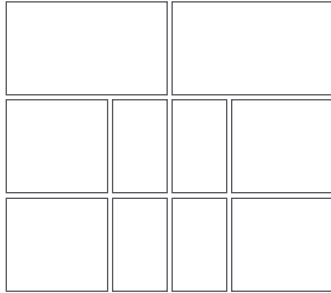

UNITS



19.5 x 13 x 2 in
495 x 330 x 50 mm
Units/bundle: 24
Units/layer: 2



13 x 13 x 2 in
330 x 330 x 50 mm
Units/bundle: 48
Units/layer: 4



6.5 x 13 x 2 in
165 x 330 x 50 mm
Units/bundle: 48
Units/layer: 4

NOTES

For pedestrian use only. Large format slabs with natural textured finish. DesignLoc technology provides a highly refined and detailed surface, with integral colouring. Border or accent with Adelaide 50, Lyra, Richmond 50 or Tresca.

Sold and packaged together in a 1:2:2 ratio. Plate tamper not recommended.

BUNDLE SPECIFICATIONS

	IMPERIAL	METRIC
Coverage	125.4 ft ²	11.64 m ²
Weight	3010 lbs	1365 kg
Layers	12	
Coverage per layer	10.45 ft ²	0.97 m ²
Lineal coverage	117 ft / 78 ft	35.64 m / 23.76 m
Lineal coverage per layer	9.75 ft / 6.5 ft	2.97 m / 1.98 m

COLOURS

Beige Mix
Carrara (NEW)
Driftwood
Glacier Creek
Grey Mix

PATTERNS

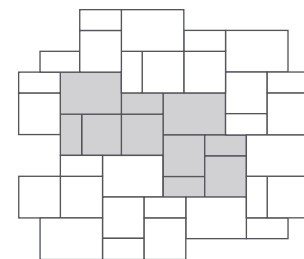
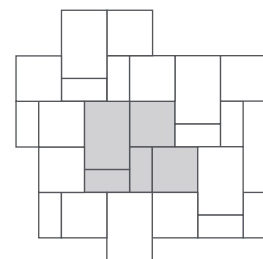
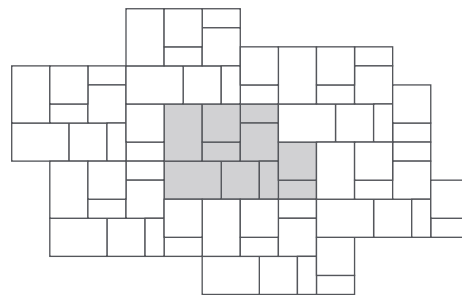

13" Soldier Course



19.5" Soldier Course

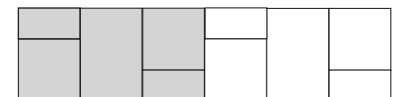

RICHMOND 50

SIGNATURE SERIES SLAB / 50MM /  



BUNDLE OVERVIEW



UNIT



6.5 x 13 x 2 in
 165 x 330 x 50 mm
 Units/bundle: 252
 Units/layer: 21

NOTES

For pedestrian use only. Can be used on its own, or as an accent and/or border for 50mm line of slabs. Subtle textured surface provides striking interest.

Plate tamper not recommended.

BUNDLE SPECIFICATIONS

IMPERIAL

METRIC

	IMPERIAL	METRIC
Coverage	147.6 ft ²	13.65 m ²
Weight	3542 lbs	1606.5 kg
Layers	12	
Coverage per layer	12.3 ft ²	1.14 m ²
Lineal coverage	136.5 ft / 273 ft	41.55 m / 83.1 m
Lineal coverage per layer	11.38 ft / 22.75 ft	3.46 m / 6.93 m

COLOURS

- Beige Mix
- Glacier Creek
- Grey Mix
- Ultra Black

PATTERNS

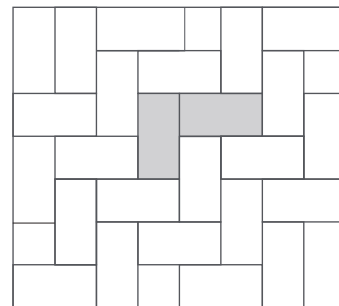
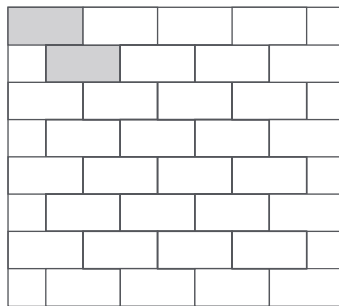

ADELAIDE 50

SIGNATURE SERIES SLAB / 50MM /  



BUNDLE OVERVIEW



UNIT

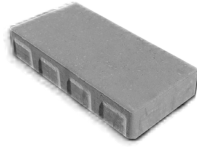

6.5 x 13 x 2 in
165 x 330 x 50 mm
Units/bundle: 252
Units/layer: 21

NOTES

For pedestrian use only. Can be used on its own or as a modern accent and/or border for 50mm line of slabs. The smooth surface provides a contemporary finish.

Plate tamper not recommended.

BUNDLE SPECIFICATIONS

IMPERIAL

METRIC

	IMPERIAL	METRIC
Coverage	147.6 ft ²	13.65 m ²
Weight	3542 lbs	1606.5 kg
Layers	12	
Coverage per layer	12.3 ft ²	1.14 m ²
Lineal coverage	136.5 ft / 273 ft	41.55 m / 83.1 m
Lineal coverage per layer	11.38 ft / 22.75 ft	3.46 m / 6.93 m

COLOURS

Glacier Creek
Grey
Ultra Black

PATTERNS

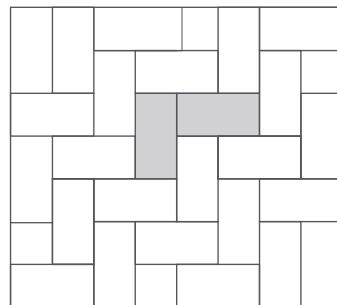
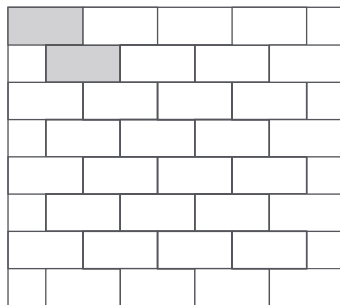

FLAGSTONE

CLASSIC SERIES SLAB / 45MM / 



BUNDLE OVERVIEW

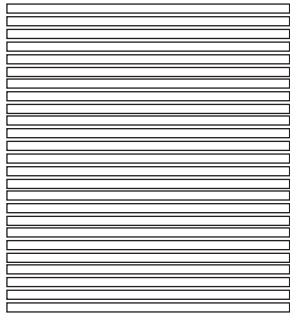

UNIT

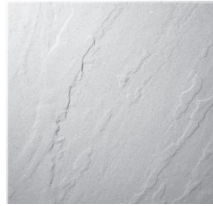

23.62 x 23.62 x 1.75 in
600 x 600 x 45 mm
Units/bundle: 25

NOTES

For pedestrian use only. Naturally inspired flagstone finish. Classic slab, does not include spacer bars. The use of a plate tamper is not permitted.

*Sold in full bundles only.
Plate tamper not permitted.

BUNDLE SPECIFICATIONS

IMPERIAL

METRIC

	IMPERIAL	METRIC
Coverage	97 ft ²	9 m ²
Weight	2103 lbs	953.68 kg
Units	25	
Coverage per unit	3.87 ft ²	0.36 m ²
Lineal coverage	49.21 ft	15 m
Lineal coverage per unit	1.97 ft	0.6 m

COLOURS

Grey
Sahara Blend

PATTERNS

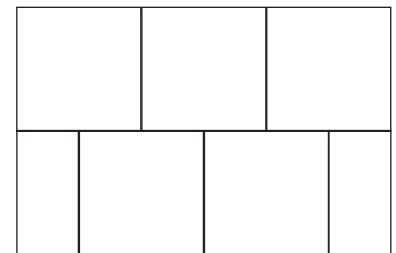
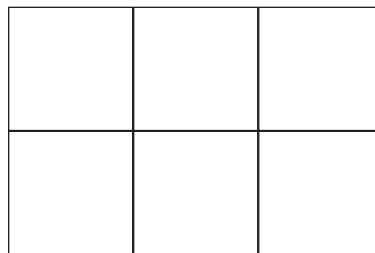

STANDARD™ PRESS

CLASSIC SERIES SLAB / 45MM, 50MM & 65MM / 



24x30

23.62 x 29.52 x 1.75 in
600 x 750 x 45 mm

	IMPERIAL	METRIC
Coverage	121 ft ²	11.25 m ²
Weight	2642 lbs	1198.28 kg
Units	25	
Coverage per unit	4.84 ft ²	0.45 m ²
Lineal coverage	49.21 ft / 61.52 ft	15 m / 18.75 m
Lineal coverage per unit	1.97 ft / 2.46 ft	0.6 m / 0.75 m

16x16

15.75 x 15.75 x 1.75 in
400 x 400 x 45 mm

	IMPERIAL	METRIC
Coverage	103 ft ²	9.6 m ²
Weight	2070 lbs	939 kg
Units	60	
Coverage per unit	1.72 ft ²	0.16 m ²
Lineal coverage	78.74 ft	24 m
Lineal coverage per unit	1.31 ft	0.4 m

24x24

23.62 x 23.62 x 1.75 in
600 x 600 x 45 mm

Coverage	97 ft ²	9 m ²
Weight	2103 lbs	953.68 kg
Units	25	
Coverage per unit	3.87 ft ²	0.36 m ²
Lineal coverage	49.21 ft	15 m
Lineal coverage per unit	1.97 ft	0.6 m

24x24 (50MM SPECIAL ORDER)

23.62 x 23.62 x 2 in
600 x 600 x 50 mm

Coverage	81.4 ft ²	7.56 m ²
Weight	2083 lbs	945 kg
Units	21	
Coverage per unit	3.87 ft ²	0.36 m ²
Lineal coverage	41.34 ft	12.6 m
Lineal coverage per unit	1.97 ft	0.6 m

24x24 (65MM SPECIAL ORDER)

23.62 x 23.62 x 2.5 in
600 x 600 x 65 mm

Coverage	58 ft ²	5.4 m ²
Weight	2100 lbs	952.3 kg
Units	15	
Coverage per unit	3.87 ft ²	0.36 m ²
Lineal coverage	29.53 ft	9 m
Lineal coverage per unit	1.97 ft	0.6 m

12x24

11.81 x 23.62 x 1.75 in
300 x 600 x 45 mm

Coverage	48 ft ²	4.5 m ²
Weight	1024 lbs	464.59 kg
Units	25	
Coverage per unit	1.93 ft ²	0.18 m ²
Lineal coverage	24.61 ft / 49.21 ft	7.5 m / 15 m
Lineal coverage per unit	0.98 ft / 1.97 ft	0.3 m / 0.6 m

COLOURS

Charcoal (Available in 600x600x45mm only)

Grey (All colours and sizes)

Red (Available in 600x600 & 400x400x45mm only)

NOTES

For pedestrian use only. Classic slabs do not include spacer bars.

All sizes sold and packaged separately. Sold in full bundles only.

The use of a plate tamper is not permitted.

BASKETWEAVE™

CLASSIC SERIES SLAB / 45MM, 50MM & 65MM / 



24x30

23.62 x 29.52 x 1.75 in
600 x 750 x 45 mm

	IMPERIAL	METRIC
Coverage	121 ft ²	11.25 m ²
Weight	2642 lbs	1198.28 kg
Units	25	
Coverage per unit	4.84 ft ²	0.45 m ²
Lineal coverage	49.21 ft / 61.52 ft	15 m / 18.75 m
Lineal coverage per unit	1.97 ft / 2.46 ft	0.6 m / 0.75 m

12x24

11.81 x 23.62 x 1.75 in
300 x 600 x 45 mm

Coverage	48 ft ²	4.5 m ²
Weight	1024 lbs	464.59 kg
Units	25	
Coverage per unit	1.93 ft ²	0.18 m ²
Lineal coverage	24.61 ft / 49.21 ft	7.5 m / 15 m
Lineal coverage per unit	0.98 ft / 1.97 ft	0.3 m / 0.6 m

24x24

23.62 x 23.62 x 1.75 in
600 x 600 x 45 mm

	IMPERIAL	METRIC
Coverage	97 ft ²	9 m ²
Weight	2103 lbs	953.68 kg
Units	25	
Coverage per unit	3.87 ft ²	0.36 m ²
Lineal coverage	49.21 ft	15 m
Lineal coverage per unit	1.97 ft	0.6 m

24x24 (50MM SPECIAL ORDER)

23.62 x 23.62 x 2 in
600 x 600 x 50 mm

81.4 ft ²	7.56 m ²
2083 lbs	945 kg
21	
3.87 ft ²	0.36 m ²
41.34 ft	12.6 m
1.97 ft	0.6 m

24x24 (65MM SPECIAL ORDER)

23.62 x 23.62 x 2.5 in
600 x 600 x 65 mm

58 ft ²	5.4 m ²
2100 lbs	952.3 kg
15	
3.87 ft ²	0.36 m ²
29.53 ft	9 m
1.97 ft	0.6 m

NOTES

For pedestrian use only. Classic slabs, does not include spacer bars.
All sizes sold and packaged separately. Sold in full bundles only.
The use of a plate tamper is not permitted.

COLOURS

White



PORCELAIN SLAB / 20MM (17/18MM*) /

UNITS

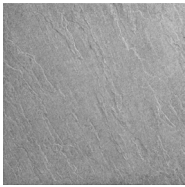

24x24 - Rectified Edge
 23.62 x 23.62 x 0.79 in
 600 x 600 x 20 mm (18)
 Units/box: 2, Units/bundle: 60



16x32 - Rectified Edge
 15.94 x 31.89 x 0.79 in
 405 x 810 x 20mm (17)
 Units/box: 2, Units/bundle: 56

NOTES

Designed and made in Italy. Light weight for easy installation. Easy to clean, and frost, mold and slip resistant. Sold by full bundle or boxes of 2. The use of a plate tamper is not permitted.

*17&18MM thickness while quantities last
 *Bundle weight includes pallet

BUNDLE SPECIFICATIONS

IMPERIAL

METRIC

Coverage	232.5 ft ²	21.6 m ²
Weight*	2116 lbs	960 kg
Weight per box	69 lbs	31.2 kg
Coverage per box	7.7 ft ²	0.72 m ²
Lineal	118 ft	35.9 m
Lineal per box	3.94 ft	1.2 m

COLOURS: Country Black Slate, Country Grey Slate, Scout White

Coverage	197.7 ft ²	18.37 m ²
Weight*	1940 lbs	880 kg
Weight per box	54.9 lbs	24.9 kg
Coverage per box	7 ft ²	0.65 m ²
Lineal	74.39 ft / 148.82 ft	22.67 m / 45.36 m
Lineal per box	2.66 ft / 5.32 ft	0.81 m / 1.62m

COLOURS: Jasmine, Universal Oak

PATTERNS

24x24

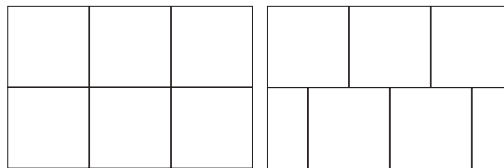

16x32

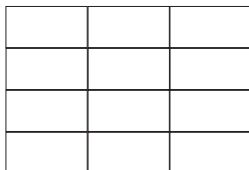
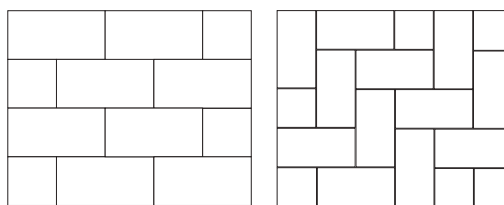





WALLS



Signature Series

46 SOHO

Classic Series

47 ARLINGTON (NEW)

48 IKON

49 HAZELTON™

50 GARDEN LOCK™

52 PARKWALL®

54 ANTICO® STACKER

55 RIDGEWALL® SRW SYSTEM

Rosetta

58 ROCKTON

59 BELVEDERE

PHYSICAL & GEOMETRICAL CHARACTERISTICS

Dry-cast Wall Units

Characteristics	ASTM C 1372 ²
Compressive strength	20.7 MPa (3000 psi) min.
Durability to freeze thaw cycles Mass loss	after 100 cycles 1% (max.)
	after 150 cycles 1.5% (max.)
Water absorption	208 kg/m ³ max. (13 lb/ft ³)
Dimension tolerance ¹	length ±3 mm (1/8")
	width ±3 mm (1/8")
	height ±3 mm (1/8")

1. The dimensional tolerance not applicable to split facings or other architectural finish

2. ASTM C1372 Standard specification for Dry-Cast, SRW units

SOHO

SIGNATURE SERIES WALL / SINGLE-SIDED / 



BLOCK UNITS (4-PACK)



13.78w x 3.94h x 8.85d in
350w x 100h x 225d mm
Units/bundle: 15
Units/layer: 5



17.72w x 3.94h x 8.85d in
450w x 100h x 225d in
Units/bundle: 15
Units/layer: 5



21.65w x 3.94h x 8.85d in
550w x 100h x 225d mm
Units/bundle: 15
Units/layer: 5



25.59w x 3.94h x 8.85d in
650w x 100h x 225d mm
Units/bundle: 15
Units/layer: 5

CORNER UNIT



13.78w x 3.94h x 8.85d in
350w x 100h x 225d mm
Units/bundle: 60
Units/layer: 20

BUNDLE SPECIFICATIONS

	IMPERIAL	METRIC
Coverage	32.25 ft ²	3 m ²
Lineal coverage	98.4 ft	30 m
Weight	3210 lbs	1457 kg
Layers	3	-
Coverage per 4 pack	2.15 ft ²	0.2 m ²
Linear coverage per 4 pack	6.56 ft	2 m
Weight per 4 pack	214 lbs	97 kg
4 packs per bundle	15	-
4 packs per layer	5	-

Coverage	22.5 ft ² / 14.4 ft ²	2.1 m ² / 1.35 m ²
Lineal coverage	69 ft / 44.4 ft	10.5 m / 6.75 m
Weight	2196 lbs	996 kg
Coverage per unit	0.62 ft ²	0.06 m ²
Linear coverage per unit	1.15 ft / 0.74 ft	0.18 m / 0.11 m
Weight per unit	36.6 lbs	16.6 kg

NOTES

A single-sided smooth wall, made with DesignLoc® surface refinement technology. Use Arlington or Garden Lock coping for ideal finish. Soho's corner creates a 22.5" x 22.5" column. Sold and packaged separately from the block units.

COLOURS

Carrara
Driftwood
Glacier Creek
Grey Mix
Ultra Black

BUNDLE OVERVIEW

BLOCK

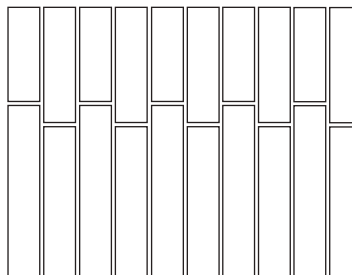

CORNER

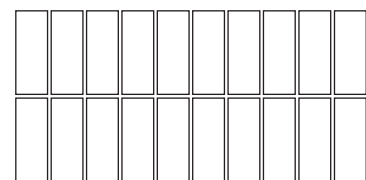

CLASSIC SERIES WALL SYSTEM / DOUBLE-SIDED SMOOTH WALL

UNITS



BLOCK
15.75w x 4.92h x 8.85d in
400w x 125h x 225d mm



CORNER
15.75w x 4.92h x 8.85d in
400w x 125h x 225d mm



COPING
15.75w x 2.36h x 10.23d in
400w x 60h x 260d mm

BUNDLE SPECIFICATIONS

	IMPERIAL	METRIC
Coverage	26.9 ft ²	2.5 m ²
Lineal Coverage	65.6 ft	20 m
Weight	2725 lbs	1236 kg
Units	50	-
Coverage per unit	0.53 ft ²	0.05 m ²
Lineal coverage per unit	1.31 ft	0.4 m

Coverage	26.9 / 15 ft ²	2.5 / 1.39 m ²
Lineal Coverage	65.6 ft	20 m
Weight	2725 lbs	1236 kg
Units	50	-
Coverage per unit	0.53 / 0.3 ft ²	0.05 / 0.027
Lineal coverage per unit	1.31 / 0.74 ft	0.4 / 0.225 m

Lineal Coverage	94.5 ft	28.8 m
Weight	2220 lbs	1007 kg
Units	72	-
Lineal coverage per unit	1.31 ft	0.4 m
Sections	4	-
Lineal coverage per section	23.6 ft	7.2 m

NOTES

Smooth double-sided wall unit with a locking feature that works in tandem with Garden Lock and Hazelton.

COLOURS

- Harbour Grey
- Nightfall
- Winterborn

BUNDLE OVERVIEW

BLOCK & CORNER	COPING

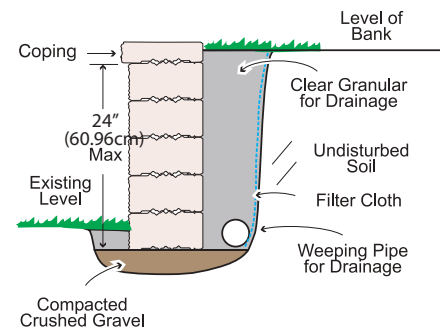

*Set-back can be erected to 36" matching Garden Lock.

IKON

CLASSIC SERIES WALL / SMOOTH FINISH / LARGE SRW



BUNDLE OVERVIEW



UNITS



BLOCK
39.4w x 6.7h x 14d in
1000w x 170h x 355d mm
Units/bundle: 9



COPING
39.4w x 6.7h x 14d in
1000w x 170h x 355d mm
Units/bundle: 9

NOTES

Large format segmental retaining wall with a double-sided smooth finish. Units can be reversed to set-back the wall system. Engineering details and services available for the Ikon wall system.

BUNDLE SPECIFICATIONS

	IMPERIAL	METRIC
Coverage	16.5 ft ²	1.53 m ²
Lineal Coverage	29.53 ft	9 m
Weight	2745 lbs	1245 kg
Weight per unit	305 lbs	138.3 kg
Coverage per unit	1.83 ft ²	0.17 m ²
Lineal coverage per unit	3.28 ft	1 m

COLOURS

Grey
Sahara Blend
Ultra Black

DESIGN OPTIONS

VERTICAL



Alternate the direction of units each row. Off-set locking feature align to create vertical finish.

30MM OFF-SET



Install units in the same direction. Off-set locking feature creates a 30mm set back.

30MM CUSTOMIZED OFF-SET



Manipulate the direction of units at desired rows. Off-set locking feature allows for customized design and finish.

Off-Set Locking System

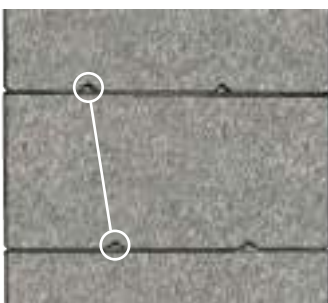

HAZELTON

CLASSIC SERIES WALL SYSTEM / DOUBLE-SIDED



UNITS

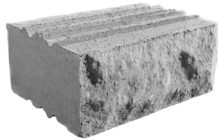

BLOCK

11.81w x 4.92h x 8.85d in
300w x 125h x 225d mm
Units/bundle: 60



CORNER

12.8w x 4.92h x 6.9d in
325w x 125h x 175d mm
Units/bundle: 48

BUNDLE SPECIFICATIONS

	IMPERIAL	METRIC
Coverage	24.21 ft ²	2.25 m ²
Lineal Coverage	59.05 ft	18 m
Weight	2296 lbs	1041.5 kg
Weight per unit	38.3 lbs	17.4 kg
Coverage per unit	0.404 ft ²	0.038 m ²
Lineal coverage per unit	0.984 ft	0.3 m

	IMPERIAL	METRIC
Coverage	21 ft ² / 11.3 ft ²	1.95 m ² / 1.05 m ²
Lineal Coverage	51.2 ft / 27.6 ft	15.6 m / 8.4 m
Weight	1642 lbs	744 kg
Weight per unit	34.2 lbs	15.5 kg
Coverage per unit	0.44 ft ² / 0.23 ft ²	0.04 m ² / 0.02 m ²
Lineal coverage per unit	1.06 ft / 0.57 ft	0.32 m / 0.17 m

NOTES

A double-sided textured wall with a locking system that allows for vertical or set-back designs. The corner creates a 20" x 20" column. Block and corner units are sold separately. Arlington, Montana, Riviera, or Garden Lock coping are ideal to complete Hazelton wall.

BUNDLE OVERVIEW

BLOCK

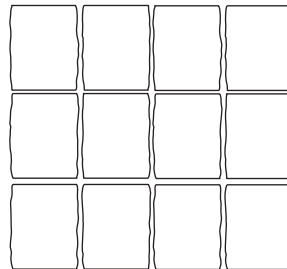

CORNER

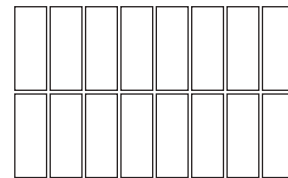

COLOURS

Beige Mix
Grey Mix
Ultra Black

TYPICAL CROSS SECTIONS

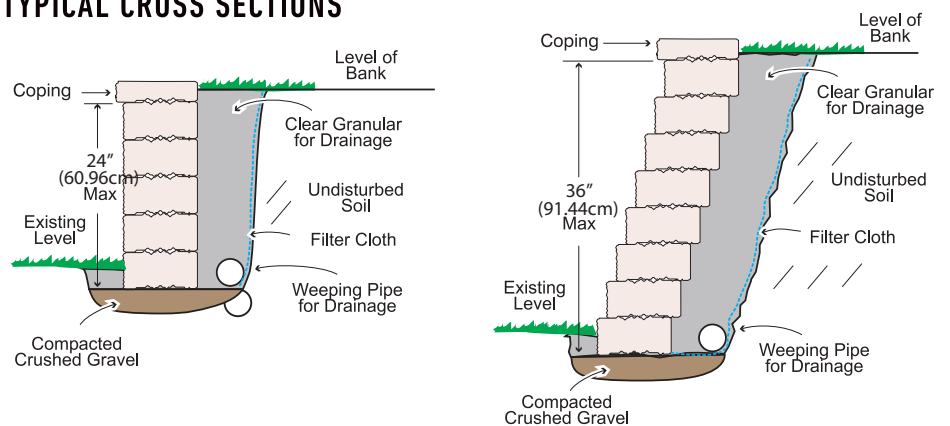

GARDEN LOCK™

CLASSIC SERIES WALL SYSTEM / SPLIT-FACE / DOUBLE-SIDED

BUNDLE OVERVIEW

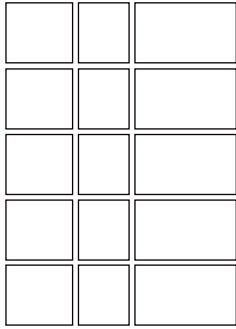

TRIPLE UNIT



Large Unit
14.96w x 4.92h x 8.85d in
380w x 125h x 225d mm
Units: 25



Medium Unit
9.84w x 4.92h x 8.85d in
250w x 125h x 225d mm
Units: 25



Small Unit
7.48w x 4.92h x 8.85d in
190w x 125h x 225d mm
Units: 25

NOTES

A double-sided split face wall that can be installed vertically or set-back. Specific medium blocks can be installed on their side, identified with locking feature along the vertical side of block unit. Triple units are sold and packaged together in a 1:1:1 ratio. Use Arlington or Garden Lock coping for best finish.

BUNDLE SPECIFICATIONS

	IMPERIAL	METRIC
Coverage	27.5 ft ²	2.55 m ²
Lineal Coverage	67.26 ft	20.5 m
Weight	3113 lbs	1412.16 kg
Weight per triple	124.5 lbs	56.5 kg
Coverage per triple	1.1 ft ²	0.1 m ²
Lineal coverage per triple	2.69 ft	0.82 m
Sections	5	-
Coverage per section	5.5 ft ²	0.51 m ²
Lineal coverage per section	13.45 ft	4.1 m

COLOURS

Beige Mix
Grey
Grey Mix
Rustic Salmon Mix
Ultra Black*
Winterborn

*Straight coping only

TYPICAL CROSS SECTIONS

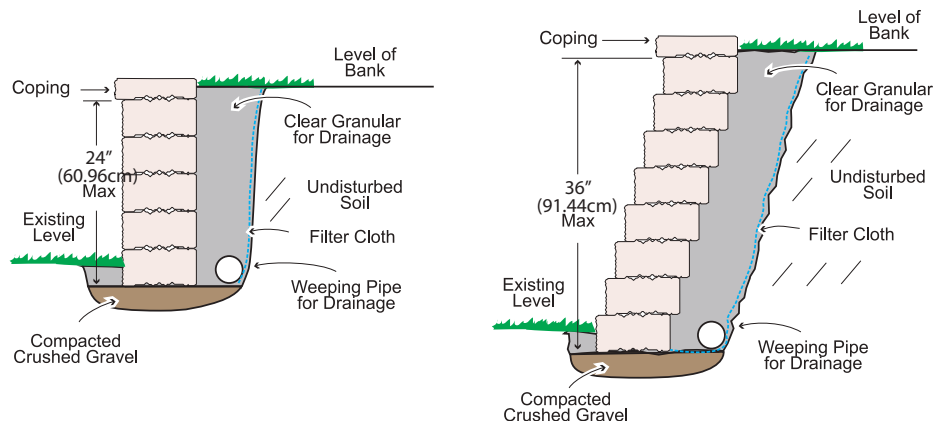



UNIT

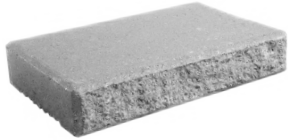

STRAIGHT COPING

15.74w x 2.95h x 10.23d in
400w x 75h x 260d mm



CORNER

13.46w x 4.92h x 8.85d in
342w x 125h x 225d mm



WEDGE BLOCK

8.07(5.31)w x 4.92h x 8.85d in
205(135)w x 125d x 225d mm



WEDGE COPING

8.23(5.17)w x 2.95h x 10.23d in
209(131)w x 75h x 260d mm

BUNDLE SPECIFICATIONS

IMPERIAL

METRIC

Lineal Coverage	84 ft	25.6 m
Weight	2458 lbs	1114.75 kg
Units	64	-
Lineal coverage per unit	1.31 ft	0.4 m
Sections	4	-
Lineal coverage per section	21 ft	6.4 m

Coverage	18.3 ft ² / 11.8 ft ²	1.7 m ² / 1.1 m ²
Weight	1786 lbs	810 kg
Units	40	-
Coverage per unit	0.4 ft ² / 0.3 ft ²	0.04 m ² / 0.03 m ²
Lineal coverage	44.9 ft / 29.5 ft	13.68 m / 9 m
Lineal coverage per unit	1.12 ft / 0.74 ft	0.34 m / 0.23 m

Coverage	34.7 ft ² / 23 ft ²	3.22 m ² / 2.14 m ²
Weight	3013 lbs	1366.45 kg
Units	125	
Coverage per unit	0.32 ft ² / 0.21 ft ²	0.03 m ² / 0.02 m ²
Lineal coverage	84.06 ft / 55.38 ft	25.63 m / 16.88 m
Lineal coverage per unit	0.66 ft / 0.46 ft	0.2 m / 0.14 m

Weight	2635 lbs	1195.31 kg
Units	160	
Lineal coverage	87.89 ft / 55.25 ft	26.76 m / 16.82 m
Lineal coverage per unit	0.55 ft / 0.35 ft	0.17 m / 0.11 m

NOTES

// 20 Wedge blocks and 20 Wedge units make a circle with 53.5" outside diamtere and 33" inside diameter.

// Corner creates a 22.3" x 22.3" column base

PARKWALL®

CLASSIC SERIES WALL SYSTEM / SPILT-FACE / DOUBLE-SIDED OPTION / SINGLE SIDE SMOOTH OPTION

UNITS



REGULAR & TAPERED BLOCK
7.87w x 5.9h x 11.61d in
200w x 150h x 295d mm



CORNER
7.87w x 5.9h x 11.61d in
200w x 150h x 295d mm



COPING
23.62w x 2.95h x 11.81d in
600w x 75h x 300d mm

NOTES

A single sided split face wall, with a double-sided option. Regular and tapered blocks can be split along back joint to remove smooth face and create double-sided finish. Can be installed vertically or set-back, front-facing or reversed, or any combination. Alternate a full 4 corner column row of the same indicated corners (Rights / Lefts) to make a 19.5" x 19.5" column base.

BUNDLE SPECIFICATIONS

IMPERIAL

METRIC

Coverage	20 ft ²	1.85 m ²
Lineal Coverage	40 ft	12 m
Weight	2575 lbs	1167.95 kg
Units	60	-
Coverage per unit	0.34 ft ²	0.03 m ²
Lineal coverage per unit	0.67 ft	0.2 m

Coverage	-	-
Lineal Coverage	15.75 ft / 23.23 ft	4.8 m / 7.08 m
Weight	1064 lbs	482.6 kg
Units	24	-
Coverage per unit	-	-
Lineal coverage per unit	0.66 ft / 0.97 ft	0.2 m / 0.3 m

Lineal Coverage	64 ft	19.2 m
Weight	2143 lbs	972 kg
Units	32	-
Lineal coverage per unit	2 ft	0.6 m
Sections	4	-
Lineal coverage per section	16 ft	4.8 m

COLOURS

Beige Mix
Grey
Grey Mix
Red Mix
Sahara Blend
Salmon Mix
Ultra Black (coping only)
Winterborn



BUNDLE OVERVIEW

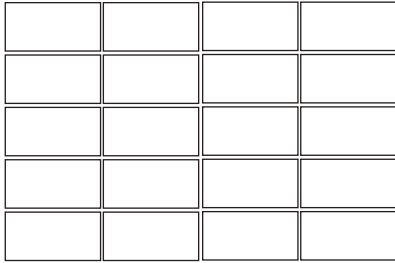

REGULAR & TAPERED BLOCK

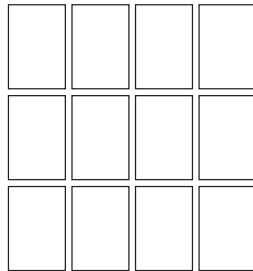

CORNERS

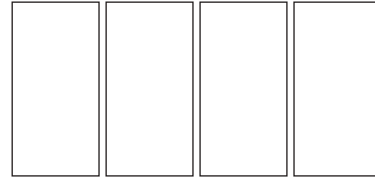

COPING

TYPICAL CROSS SECTIONS

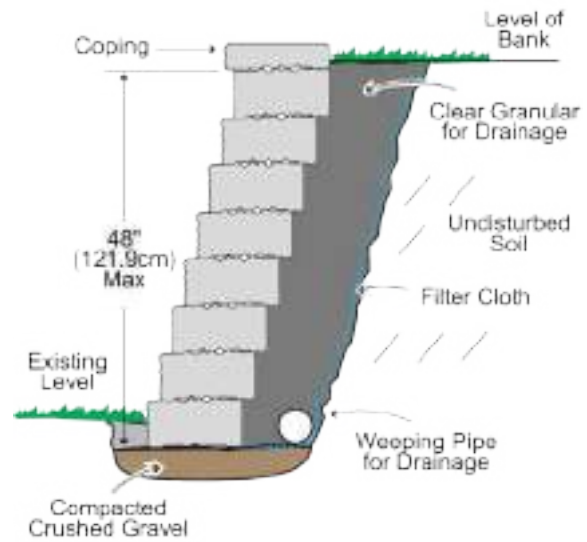
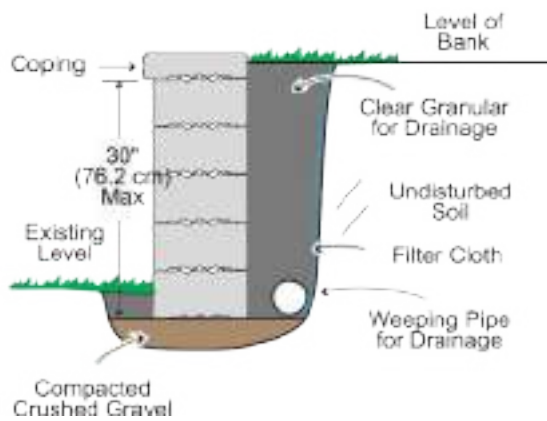

DESIGN VERSATILITY

Split-Face Vertical



Smooth-Face Accent



In or Out-Set Accent



Smooth-Face In or Out-Set



Combination Accenting



No block manipulation required. Simply turn the block, or set in and out as desired along the patented locking feature.

ANTICO® STACKER

STACK WALL / TUMBLED



BUNDLE OVERVIEW

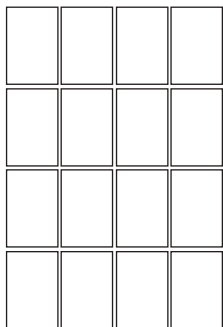

UNIT



11.81w x 3.92h x 7.87d in
300w x 100h x 200d mm
Units/bundle: 96

NOTES

A tumbled unit with smooth antiqued surface. Stacker is a versatile stacking block that can be applied to multiple applications such as garden walls, outdoor kitchens, columns, water and fire features. Creates a 19.5" x 19.5" column base.

COLOURS

Beige Mix
Grey Mix
Sahara Blend
Ultra Black

BUNDLE SPECIFICATIONS

IMPERIAL

METRIC

	IMPERIAL	METRIC
Coverage	31 ft ² / 20.67 ft ²	2.88 m ² / 1.92 m ²
Lineal Coverage	94.5 ft / 63 ft	19.2 m / 28.8 m
Weight	2861 lbs	1297.6 kg
Weight per unit	29.8 lbs	13.5 kg
Coverage per unit	0.32 ft ² / 0.21 ft ²	0.03 m ² / 0.02 m ²
Lineal coverage per unit	0.98 ft / 0.66 ft	0.2 m / 0.3 m
Sections	4	-
Coverage per section	7.75 ft ² / 5.17 ft ²	0.72 m ² / 0.48 m ²
Lineal coverage per section	23.62 ft / 15.75 ft	4.8 m / 7.2 m

RIDGEWALL®

LARGE SEGMENTAL RETAINING WALL SYSTEM / ENGINEERING SERVICES AVAILABLE



UNITS



BLOCK UNIT

39.4w x 7.68h x 17.1d in
1000w x 195h x 435d mm



90° CORNER UNIT

36.9w x 7.68h x 17.1d in
937.5w x 195h x 435d mm



45° CORNER UNIT

39.4w x 7.68h x 17.1d in
1000w x 195h x 435d mm



COPING UNIT

39.4w x 7.68h x 19.7d in
1000w x 195h x 500d mm

BUNDLE SPECIFICATIONS

IMPERIAL

METRIC

Coverage	13.23 ft ²	1.2 m ²
Lineal Coverage	19.68 ft	6 m
Weight	2370 lbs	1075.2 kg
Units	6	-
Coverage per unit	2.1 ft ²	0.2 m ²
Lineal coverage per unit	3.28 ft	1 m

Coverage	17.22 ft ²	1.62 m ²
Lineal Coverage	26.97 ft	8.24 m
Weight	2340 lbs	1061.4 kg
Units	6	-
Coverage per unit	2.87 ft ²	0.27 m ²
Lineal coverage per unit	4.49 ft	1.37 m

Coverage	13.5 ft ²	1.26 m ²
Lineal Coverage	21.45 ft	6.56 m
Weight	2226 lbs	1009.8 kg
Units	6	-
Coverage per unit	2.25 ft ²	0.21 m ²
Lineal coverage per unit	3.57 ft	1.09 m

Coverage	13.23 ft ²	1.2 m ²
Lineal Coverage	19.68 ft	6 m
Weight	2982 lbs	1352.4 kg
Units	6	-
Coverage per unit	2.1 ft ²	0.2 m ²
Lineal coverage per unit	3.28 ft	1 m

RIDGEWALL®

LARGE SEGMENTAL RETAINING WALL SYSTEM

BUNDLE OVERVIEW (ALL UNITS)



NOTES

When installing the Ridgewall, install units ridge-to-ridge and key-to-key where possible. Can be installed vertically or with 50mm set-back. Engineering services available, call 1-800-BESTWAY (237-8929) or contact your sales rep for more information.

COLOURS

Beige Mix*
Grey
Grey Mix*

*Only available in coping unit

RIDGE & KEY SYSTEM

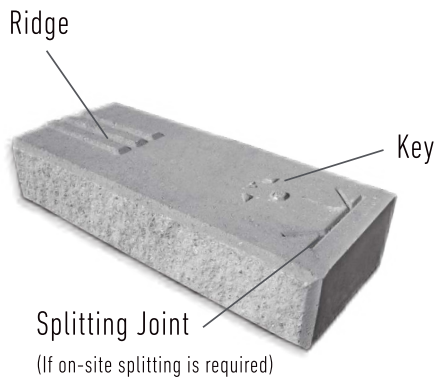

TYPICAL CROSS SECTION

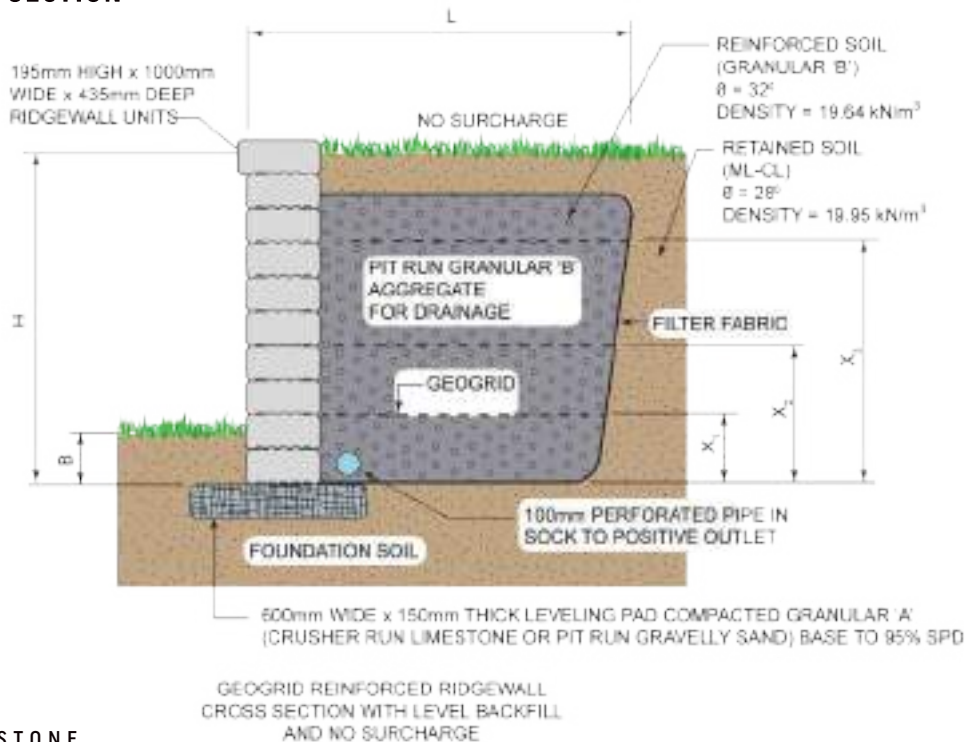

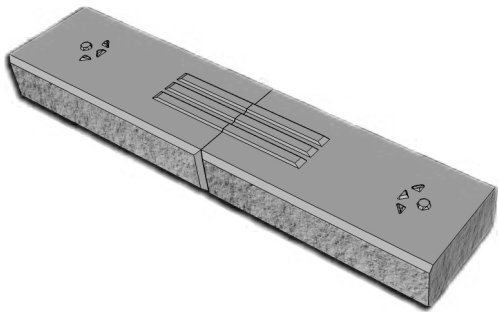

Ridge-to-Ridge & Key-to-Key Installation (Best Practice where possible)

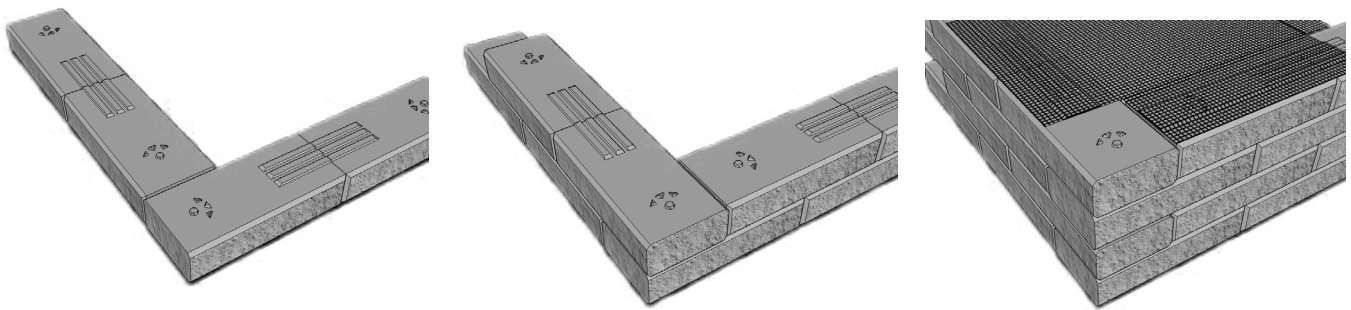

90 Corner - Row 1 & 2 (Continue same sequence for following rows) + typical grid placement

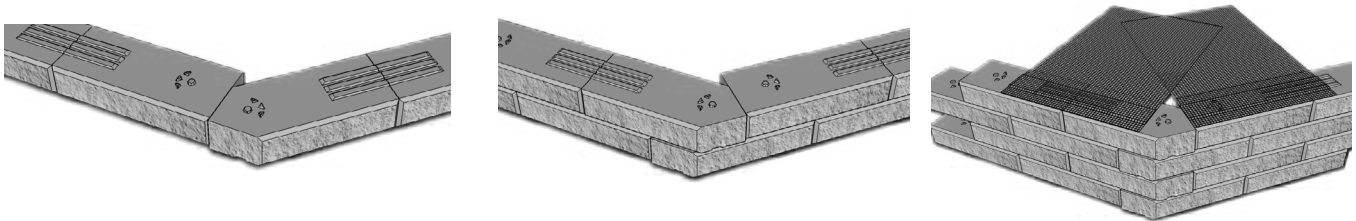

45 Corner - Row 1 & 2 (Continue same sequence for following rows) + typical grid placement

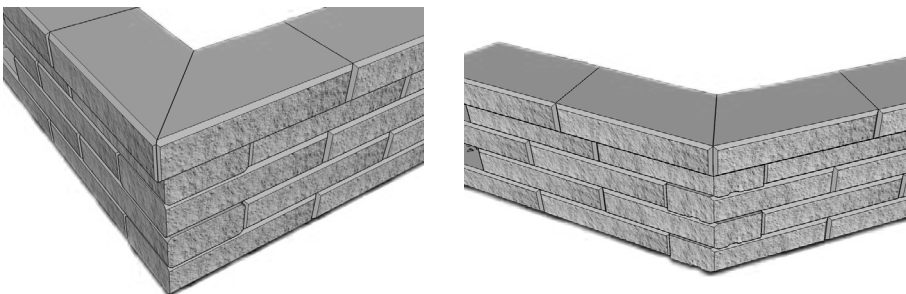

90 & 45 Corner - Finished

ROCKTON

DOUBLE-SIDED / EMBOSSED NATURAL FINISH



BLOCK UNITS (6 PACK)



12w x 6h x 10.5d in
305w x 153h x 267d mm
Units/bundle: 3
Units/layer: 1



21w x 6h x 10.5d in
533w x 153h x 267d mm
Units/bundle: 6
Units/layer: 2



30w x 6h x 10.5d in
762w x 153h x 267d mm
Units/bundle: 3
Units/layer: 1



42w x 6h x 10.5d in
1067w x 153h x 267d mm
Units/bundle: 6
Units/layer: 2



CORNER
21w x 6h x 10.5d in
533w x 153h x 267d mm
Units/bundle: 24

BUNDLE SPECIFICATIONS

	IMPERIAL	METRIC
Coverage	21 ft ²	1.95 m ²
Lineal coverage	42 ft	12.8 m
Weight	2500 lbs	1134 kg
Layers (6 packs)	3	-
Coverage per layer (6 pack)	7 ft ²	0.65 m ²
Lineal coverage per layer (6 pack)	14 ft	4.26 m
Weight per layer (6 pack)	833 lbs	378 kg

Coverage	31.5 ft ²	2.9 m ²
Lineal coverage	63 ft	19.2 m
Weight	2500 lbs	1134 kg
Coverage per unit	1.31 ft ²	0.12 m ²
Lineal coverage per unit	2.6 ft	0.79 m
Weight per unit	104 lbs	47.25 kg

BUNDLE OVERVIEW (6 Pack)

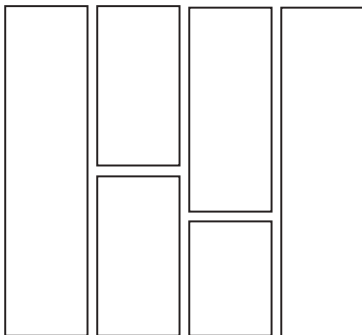

NOTES

Rockton provides a large format natural finish. Corner units create a 22.5"x22.5" column. Block units sold and packaged together. Each bundle layer represents a 6 pack.

COLOURS

Fond du Lac
Manitou Blend

BELVEDERE

DOUBLE-SIDED / EMBOSSED NATURAL FINISH



UNITS



BLOCK - 6 PACK

6/4w x 3&6h x 9d in
153/102w x 76&153h x 229d mm



12/10w x 3&6h x 9d in
305/254w x 76&153h x 229d mm

18/16w x 3/6h x 9d in
457/406w x 76&153h x 229d mm



COPING - 3 PACK

6/4w x 2.25h x 10.25d in
153/102w x 57h x 260d mm

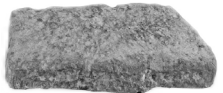

12/10w x 2.25h x 10.25d in
305/254w x 57h x 260d mm

18/16w x 2.25h x 10.25d in
457/406w x 57h x 260d mm



CORNER - DOUBLE PACK

14/15w x 3h x 9d in
356/381w x 76h x 229d mm

15/14w x 6h x 9d in
381/356w x 153h x 229d mm

BUNDLE SPECIFICATIONS

IMPERIAL

METRIC

Coverage	27 ft ²	2.51 m ²
Lineal coverage (3" h+6" h)	72 ft	22 m
Weight	2475 lbs	1123 kg
6 packs	12	-
Coverage per 6 pack	2.25 ft ²	0.21 m ²
Lineal coverage per 6 pack	6 ft	1.8 m
Weight per layer 6 pack	206 lbs	93.6 kg

Lineal coverage	66 ft	20.12 m
Weight	1550 lbs	703 kg
3 packs	24	-
Lineal coverage per 3 pack	2.75 ft	0.84 m
Weight per 3 pack	65 lbs	29 kg

Coverage	24 ft ²	2.23 m ²
Lineal coverage (3" h+6" h)	38.7 ft	11.8 m
Weight	1520 lbs	690 kg
Double packs	16	-
Coverage per double pack	1.5 ft ²	0.14 m ²
Lineal coverage per double pack	2.42 ft	0.74 m
Weight per double pack	95 lbs	43.1 kg

BUNDLE OVERVIEW

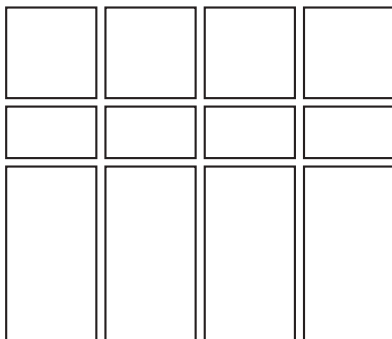

6 PACK BLOCKS (3" & 6" ROWS ALTERNATE)



NOTES

Half of the Triple Coping units have one finished edge. Creates a 27" x 27" x 2.5" column base. Column Cap available, 10 units per pallet.

COLOURS

Manitou Blend
Windsor Blend





STEPS, CAPS & CURBS

Steps

- 62 CAMDEN STEP
- 63 IKON STEP
- 63 RIDGE™ STEP

Caps

- 64 SOPRA COPING
- 64 MONTANA CAP
- 64 MONTANA COLUMN CAP
- 64 RIVIERA CAP
- 65 DIMENSIONAL
- 65 BAROLLO™ ROUND EDGE
- 65 BULLNOSE COLUMN CAP
- 65 PARKWALL® COLUMN CAP

Curbs

- 66 ANTICO® CURB
- 66 GARDEN CURB
- 66 DRIVEWAY CURB

STEPS



CAMDEN STEP

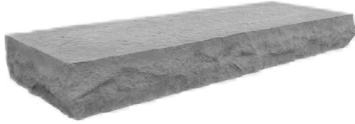

72w x 6h x 16d in
1830w x 152h x 406d mm



48w x 6h x 16d in
1219w x 152h x 406d mm

14" FILLER



14w x 7d x 6h in
356w x 178d x 152h mm

28" FILLER



28w x 7d x 6h in
711w x 178d x 152h mm

BUNDLE SPECIFICATIONS

IMPERIAL

METRIC

Weight	2144 lbs	972 kg
Units	4	-
Lineal coverage	24 ft	7.31 m
Lineal coverage per unit	6 ft	1.83 m

COLOUR: Ebony, Sahara Blend

Weight	1324 lbs	600.73 kg
Units	6	-
Lineal coverage	24 ft	7.32 m
Lineal coverage per unit	4 ft	1.22 m

COLOUR: Ebony, Sahara Blend

Weight	2232 lbs	1012 kg
Units	48	-
Lineal	-	-
Lineal per unit	-	-

COLOUR: Ebony, Sahara Blend

Weight	2232 lbs	1012 kg
Units	24	-
Lineal coverage	-	-
Lineal coverage per unit	-	-

COLOUR: Ebony, Sahara Blend

IKON STEP



39.4w x 6.7h x 14d in
1000w x 170h x 355d mm

Weight	2745 lbs	1245 kg
Units	9	
Lineal coverage	29.5 ft	9 m
Lineal coverage per unit	3.28 ft	1 m

COLOUR: Grey, Sahara Blend, Ultra Black

RIDGE™ STEP



39.4w x 7.68h x 19.7d in
1000w x 195h x 500d mm

Weight	2982 lbs	1352.4 kg
Units	6	
Lineal coverage	19.68 ft	6 m
Lineal coverage per unit	3.28 ft	1 m

COLOUR: Beige Mix, Grey, Grey Mix



CAPS



SOPRA COPING

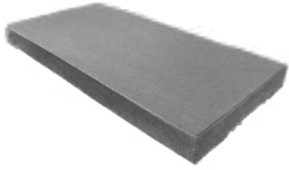

28w x 14d x 2.36h in
710w x 355d x 60h mm

BUNDLE SPECIFICATIONS

IMPERIAL

METRIC

Weight	2079 lbs	943 kg
Units	27	-
Lineal coverage	63 ft	19.2 m
Lineal coverage per unit	2.3 ft	0.7 m

COLOUR: Grey, Sahara Blend, Ultra Black

MONTANA CAP



21.3w x 10.6d x 2h in
540w x 270d x 50h mm

BUNDLE SPECIFICATIONS

IMPERIAL

METRIC

Weight	825 lbs	374 kg
Units	22	-
Lineal coverage	38.9 ft	11.9 m
Lineal coverage per unit	1.77 ft	0.54 m

COLOUR: Ebony, Granite, Sandstone

MONTANA COLUMN CAP

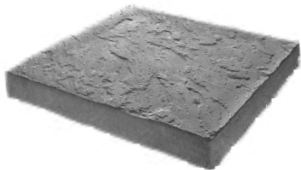

23.62w x 23.62d x 2.95h in
600w x 600d x 75h mm

Weight	1096 lbs	496 kg
Units	8	-
Lineal coverage	-	-
Lineal coverage per unit	-	-

COLOUR: Ebony, Granite, Sandstone

RIVIERA CAP



23.6w x 11.8d x 2.36h in
600w x 300d x 60h mm

Weight	873 lbs	396 kg
Units	18	-
Lineal coverage	35.4 ft	10.8 m
Lineal coverage per unit	1.97 ft	0.6 m

COLOUR: Ebony, Granite, Sandstone



DIMENSIONAL Double Pack



24" COPING
24w x 13d x 2.5h in
600w x 330d x 65h mm



18" COPING
18w x 13d x 2.5h in
450w x 330d x 65h mm

BUNDLE SPECIFICATIONS

IMPERIAL

METRIC

Coverage	7.56 ft ² / 5.68 ft ²	0.704 m ² / 0.528 m ²
Lineal coverage	63 ft	19.2 m
Weight	1950 lbs	884.5 kg
Double packs	18	-
Lineal coverage per double pack	3.5 ft	1.07 m
Weight per double pack	108 lbs	49.1 kg

BAROLLO™ ROUND EDGE



9.84w x 12.46d x 2.95h in
250w x 317d x 75h mm

COLOUR: Manitou Blend, Windsor Blend

Weight	2136 lbs	968.86 kg
Units	81	
Lineal coverage	66.42 ft	20.25 m
Lineal coverage per unit	0.82 ft	0.25 m

BULLNOSE COLUMN CAP



23.62w x 23.62w x 2.95h in
600w x 600d x 75h mm

COLOUR: Grey, Ultra Black

Weight	1036 lbs	470 kg
Units	8	
Lineal coverage	-	-
Lineal coverage per unit	-	-

PARKWALL® COLUMN CAP



23.62w x 23.62d x 2.95h in
600w x 600d x 75h mm

COLOUR: Ebony, Grey, Sahara Blend

Weight	2280 lbs	1034 kg
Units	16	
Lineal coverage	-	-
Lineal coverage per unit	-	-

COLOUR: Grey, Sahara Blend, Ultra Black

CURBS



Garden Curb



Driveway Curb

ANTICO® CURB

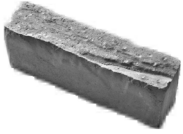

15.75w x 5.91h x 3.94d in
400w x 150h x 100d mm

BUNDLE SPECIFICATIONS

IMPERIAL

METRIC

Weight	1841 lbs	835.19 kg
Units	64	-
Lineal coverage	84 ft	25.6 m
Lineal coverage per unit	1.31 ft	0.4 m

COLOUR: Beige Mix, Grey Mix, Rustic Salmon Mix

GARDEN CURB

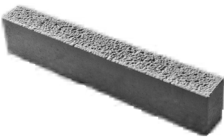

31.5w x 5.91h x 3.94d in
800w x 150h x 100d mm

Weight	2355 lbs	1068.12 kg
Units	40	-
Lineal coverage	105 ft	32 m
Lineal coverage per unit	2.63 ft	0.8 m

COLOUR: Charcoal, Grey, Red

DRIVEWAY CURB



39.4w x 5.9h x 5.9d in
1000w x 150h x 150d mm

Weight	2193 lbs	994.55 kg
Units	20	
Lineal coverage	65.6 ft	20 m
Lineal coverage per unit	3.28 ft	1 m

COLOUR: Charcoal, Grey, Red







ENVIRO

70 MODERNA® PERMEABLE PAVER

71 SOLAR REFLECTIVE ROOFTOP PAVER



MASONRY + BUILDER

72 WINDOW SILLS

72 KEYSTONE

72 SPLASH PAD

72 STEP RISERS

73 CHIMNEY CAPS

73 SIMPLICITY STEPS

MODERNA®

PERMEABLE PAVER / 70MM /   



BUNDLE OVERVIEW

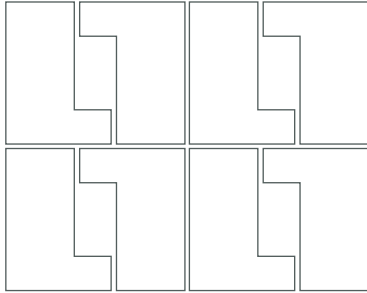

UNIT

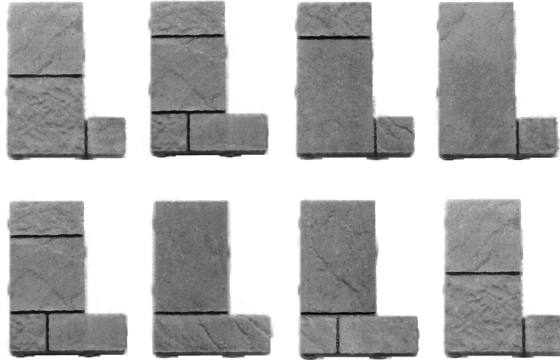

NOTES

For pedestrian and/or vehicular use. Install by layer for most random finish. Single shape false joint paver allows for easy and quick installation of your permeable project.

BUNDLE SPECIFICATIONS

IMPERIAL

Coverage	62 ft ²	5.76 m ²
Weight	1918 lbs	869.84 kg
Layers	8	
Coverage per layer	7.75 ft ²	0.72 m ²
Lineal coverage	47 ft*	14.4 m*
Lineal coverage per layer	5.875 ft*	1.8 m*

COLOURS

Beige Mix
Grey Mix

PATTERN

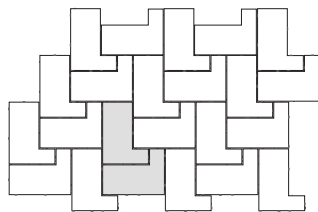

SOLAR REFLECTIVE ROOFTOP PAVER

ENVIRO SLAB / 45MM, 50MM & 65MM / 



BUNDLE OVERVIEW

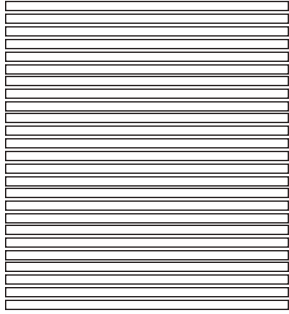

UNIT



23.62 x 23.62 x 1.75 in
600 x 600 x 45 mm
Units/bundle: 25

PEDESTALS AVAILABLE



NOTES

For pedestrian and rooftop terracing use only. Provides a smooth white surface for maximum reflectivity. Meets SRI LEED® requirements for low slope roofing of 82+. Special order item, minimum quantities and lead time required. Available 2" and 2.5" thickness with adequate volumes and lead times.

BUNDLE SPECIFICATIONS

	IMPERIAL	METRIC
Coverage	97 ft ²	9 m ²
Weight	2103 lbs	953.68 kg
Units	25	
Coverage per unit	3.87 ft ²	0.36 m ²
Lineal coverage	49.21 ft	15 m
Lineal coverage per unit	1.97 ft	0.6 m

COLOUR

SR White

BUNDLE SPECIFICATIONS

	2" (SPECIAL ORDER) 23.62 x 23.62 x 2 in 600 x 600 x 50 mm		2.5" (SPECIAL ORDER) 23.62 x 23.62 x 2.5 in 600 x 600 x 65 mm	
Coverage	81.4 ft ²	7.56 m ²	58 ft ²	5.4 m ²
Weight	2083 lbs	945 kg	2100 lbs	952.3 kg
Units	21		15	
Coverage per unit	3.87 ft ²	0.36 m ²	3.87 ft ²	0.36 m ²
Lineal coverage	41.34 ft	12.6 m	29.53 ft	9 m
Lineal coverage per unit	1.97 ft	0.6 m	1.97 ft	0.6 m

MASONRY & BUILDER

WINDOW SILLS



36w x 5.9h x 3.62d in
914w x 150h x 90d mm



36w x 5.9h x 2.95d in
914w x 150h x 75d mm

KEYSTONE



8.75/5.75w x 12.5h x 3d in
222/146w x 310h x 75d mm

SPLASH PAD



23.62w x 10.83d x 3.15h in
600w x 275d x 80h mm

STEP RISERS

29.52w x 5.9h x 3.74d in
750w x 150h x 95d mm

23.62w x 5.9h x 3.74d in
600w x 150h x 95d mm

BUNDLE SPECIFICATIONS

IMPERIAL

METRIC

Weight	2659 lbs	1206 kg
Units	44	-
Lineal	132 ft	40 m
Lineal per unit	3 ft	0.9 m

Weight	2895 lbs	1313.24 kg
Units	56	-
Lineal	168 ft	51.2 m
Lineal per unit	3 ft	0.9 m

COLOURS: Charcoal (3" Only), Grey, White

Weight	1085 lbs	492.24 kg
Units	40	-

COLOURS: Grey, White

Weight	1774 lbs	804.56 kg
Units	32	-

COLOUR: Grey

Weight	2310 lbs	1050 kg
Units	42	-

Weight	1848 lbs	840 kg
Units	42	-

COLOUR: Grey

CHIMNEY CAPS

9X9
8.86w x 8.86d x 2.95h in
225w x 225d x 75h mm

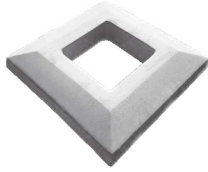

9X13
8.86w x 13d x 2.95h in
225w x 330d x 75h mm

U-CAP
8.86w x 13d x 2.95h in
225w x 330d x 75h mm

STRINGER
15.5w x 5.5d x 2.95h in
394w x 140d x 75h mm

SIMPLICITY STEPS



36"
#1 36w x 12d x 7h in / 910w x 305d x 178h mm
#2 36w x 24d x 7h in / 910w x 610d x 178h mm

48"
#1 48w x 12d x 7h in / 1215w x 305d x 178h mm
#2 48w x 24d x 7h in / 1215w x 610d x 178h mm

60" #1 / #2
#1 60w x 12d x 7h in / 1520w x 305d x 178h mm
#2 60w x 24d x 7h in / 1520w x 610d x 178h mm

72" #1 / #2
#1 72w x 12d x 7h in / 1825w x 305d x 178h mm
#2 72w x 24d x 7h in / 1825w x 610d x 178h mm

FILLER
12" 12w x 4.5d x 7h in / 305w x 115d x 178h mm
24" 24w x 5.25d x 7h in / 610w x 135d x 178h mm

PLATFORM
36" 36w x 36d x 7h in / 910w x 910d x 178h mm
48" 48w x 36d x 7h in / 1215w x 910d x 178h mm

Simplicity steps units sold in full bundles only

BUNDLE SPECS

IMPERIAL

METRIC

Weight	1334 lbs	605.09 kg
Units	20	-

Weight	1494 lbs	677.67 kg
Units	20	-

Weight	1128 lbs	511.65 kg
Units	20	-

Weight	1808 lbs	820 kg
Units	96	-

COLOUR: White

	#1 / #2	#1 / #2
Weight	1665 lbs / 1637 lbs	755.23 kg / 742.67 kg
Units	15 / 10	-

Weight	1712 lbs / 1874 lbs	776.35 kg / 850 kg
Units	12 / 10	-

Weight	893 lbs / 1207 lbs	404.83 kg / 547.26 kg
Units	5 / 5	-

Weight	1018 lbs / 1347 lbs	461.53 kg / 611.06 kg
Units	5 / 5	-

	12" / 24"	12" / 24"
Weight	30 lbs / 63 lbs	13.71 kg / 28.61 kg
Units	-	-

	36" / 48"	36" / 48"
Weight	1054 lbs / 1460 lbs	478 kg / 662.4 kg
Units	4 / 4	-

COLOUR: White

ACCESSORY ITEMS

JOINT SAND



POLYMERIC SAND

Bag 50lbs (22.7kg) 63 bags / bundle
// Signature paver and slab coverage approx. 80-100 sqft/bag
// Classic paver coverage approx. 60-80 sqft/bag

COLOURS: Beige, Black and Grey

SEALERS & CLEANERS



SEAL KING SEALERS & CLEANERS

// Water and acrylic based (19L & 4L Pails)
// High gloss and satin finish
// Cleaning Products



KIMBOL SEALERS & CLEANERS

// Water and acrylic based
// Regular and Super Shine
// Cleaning Products

ADHESIVES

BUTYL TAPE

1/4" Bead Roll 20 Lineal Feet 40 rolls/case

LANDSCAPE CONCRETE PAVERS & WALL ADHESIVE

Small Tube 10 Ounces 12 tubes/case
Large Tube 28 Ounces 12 tubes/case

AGGREGATES

BRICKSAND

Bag / Yard 50lbs (22.7kg) / Approx. 50 bags/bundle
*Regular paver coverage approximately 100 sqft/bag

CONCRETE SAND

Bag / Yard 50lbs (22.7kg) / Approx.
*1 yard covers approximately 300 sqft at 1" thickness

LIMESTONE SCREENING

Bag / Yard 50lbs (22.7kg) / Approx.
*1 yard covers approximately 150 sqft at 2" thickness

3/8" GRAVEL (Clear)

Yard
*1 yard covers approximately 150 sqft at 2" thickness

3/4" GRAVEL (Clear)

Bag Only 50lbs (22.7kg)

1/4" CHIP (HPB)

Bag / Yard 50lbs (22.7kg) / Approx.
*1 yard covers approximately 150 sqft at 2" thickness

EDGE RESTRAINTS

SNAP EDGE PAVER RESTRAINT

PLASTIC 8' Units

BRICKSTOP PAVER EDGE RESTRAINT

PLASTIC 8' Units 160 lineal feet/box 20 units/box
METAL 8'4" Units 400 lineal feet/box 48 units/box

SPIKES 10" Steel approx. 50lbs 250 pcs/ box

SALT

Bagged 44lbs (20kg) 56 bags / bundle

FABRICS

SYNTHETIC GRID

Tieback 6' x 150' (1.83m x 45.72m)

CONSTRUCTION FABRIC

Nonwoven Geotextile 5' x 360' (1.52m x 109.7m)
Nonwoven Geotextile 4' x 50' (1.2m x 15.2m)
Nonwoven Geotextile 3' x 50' (0.9m x 15.2m)
Weed Control Roll

PRECAST CONCRETE

PARKING LOT BUMPER CURBS

96x12x8" (2438x305x203mm) 520 lbs / 236.4 kg (unit)
96x10x6" (2438x254x152mm) 360 lbs / 163.6 kg (unit)

TOOLS

Pave Tool Quick-E Line
Caulking guns
Gloves
Hand tampers
Mallets
Levels
Plate Tampers
Shovels
String lines
Wheel barrows
+ MORE







RESOURCES

- 78 2021 COLOUR CHART
- 78 SOLAR REFLECTANCE INDEX
- 80 INSTALLATION GUIDE - SLABS
- 80 INSTALLATION GUIDE - SLABS ON PEDESTAL SET
- 80 INSTALLATION GUIDE - PAVERS
- 81 INSTALLATION GUIDE - PERMEABLE PAVERS
- 82 INSTALLATION GUIDE - WALLS
- 84 CARE & CONSIDERATIONS
- 85 OUTDOOR DESIGN CENTER
- 86 SAFETY PRECAUTIONS
- 87 OUR LOCATIONS

INSTALLATION GUIDES - SLABS & PAVERS

SLAB INSTALLATION TYPICAL CROSS SECTION

- 1 Best Way Stone® precast concrete slab 1 3/4" to 2" (45 to 50mm)
- 2 Sand joint fill
- 3 Bedding Sand 1" (25mm)
- 4 Geotextile 12" (300mm) wide
- 5 Plastic edge
- 6 Extra width equal to foundation thickness
- 7 Lawn
- 8 Nail
- 9 Compacted aggregate base 0 3/4" (0-20mm)
- 10 Geotextile
- 11 Subgrade

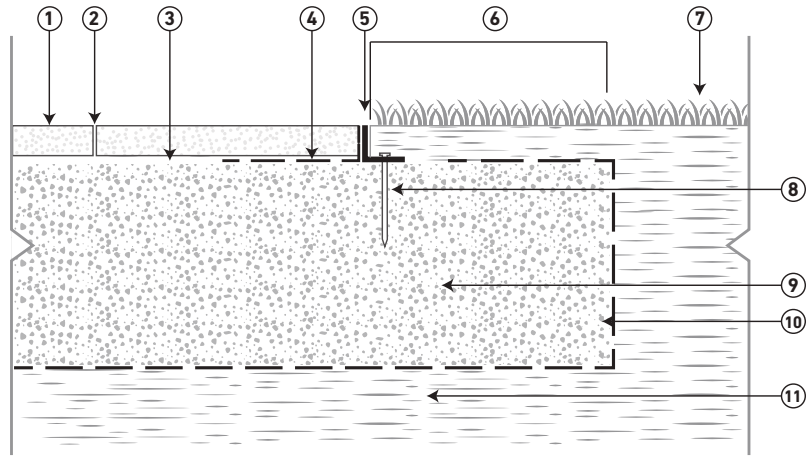

SLABS ON PEDESTAL SET

- 1 Roof deck
- 2 Waterproof membrane
- 3 Protection board
- 4 Rigid insulation
- 5 Adjustable pedestal
- 6 Best Way Stone® precast concrete slab 1 3/4" to 2 1/2" (45-65mm) thickness conforming to ASTM C 1782 and CSA A231.1
- 7 Best Way Stone® Trevista 50 slabs, 2" (50mm) thickness conforming to ASTM C 1782 and CSA A231.1
- 8 Roof drain

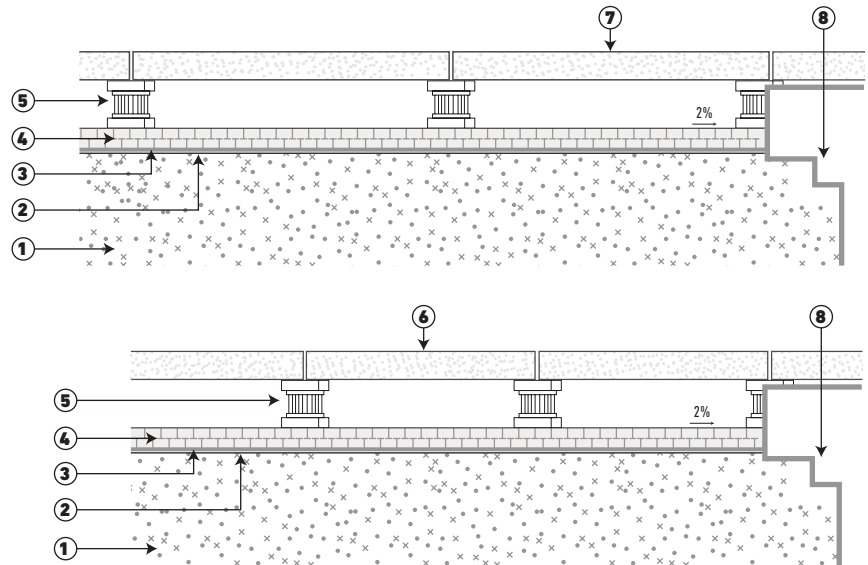

TYPICAL PAVER CROSS SECTION WITH PLASTIC EDGE

- 1 Best Way Stone® precast concrete paver 2 3/8" (60mm) thick min.
- 2 Sand joint fill
- 3 Bedding Sand 1" (25mm)
- 4 Extra width equal to foundation thickness
- 5 Lawn
- 6 Plastic edge
- 7 Nail
- 8 Geotextile
- 9 Compacted aggregate base 0 3/4" (0-20mm)
- 10 Subgrade

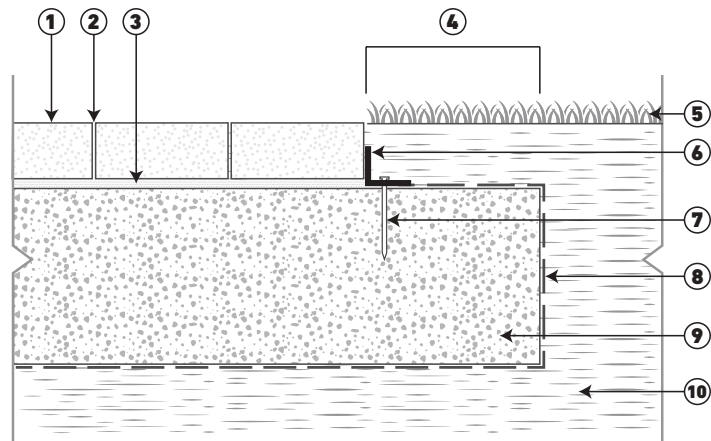

INSTALLATION GUIDES - PERMEABLE PAVER SYSTEM

SEGMENTAL PERMEABLE PAVEMENT - FULL EXFILTRATION

- 1 Moderna® Permeable Paver by Best Way Stone®
- 2 Joint filling material ASTM No 8 (CSA 2.5-10mm) aggregate
- 3 Bedding course 1 1/5" to 2" (40 to 50 mm) ASTM No 8 (CSA 2.5-10mm) aggregate
- 4 Base course 4" (100mm) ASTM No 57 (CSA 5-28mm) aggregate foundation thickness
- 5 Subbase course ASTM No 2 (CSA 40-80mm) aggregate
- 6 Geotextile
- 7 Subgrade
- 8 Concrete edge

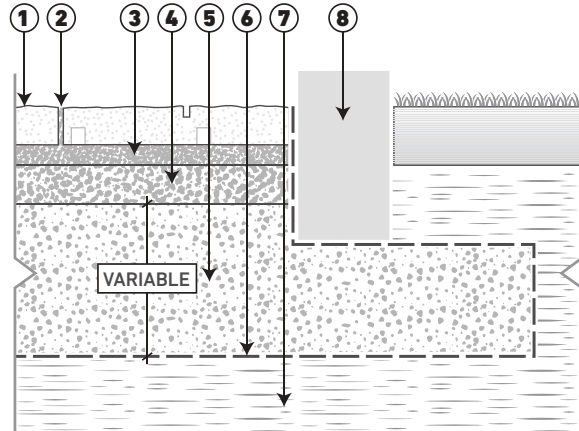

SEGMENTAL PERMEABLE PAVEMENT - PARTIAL EXFILTRATION

- 1 Moderna® Permeable Paver by Best Way Stone®
- 2 Joint filling material ASTM No 8 (CSA 2.5-10mm) aggregate
- 3 Bedding course 1 1/5" to 2" (40 to 50 mm) ASTM No 8 (CSA 2.5-10mm) aggregate
- 4 Base course 4" (100mm) ASTM No 57 (CSA 5-28mm) aggregate foundation thickness
- 5 Subbase course ASTM No 2 (CSA 40-80mm) aggregate
- 6 Geotextile
- 7 Subgrade
- 8 Concrete edge
- 9 Perforated drain connected to drainage system

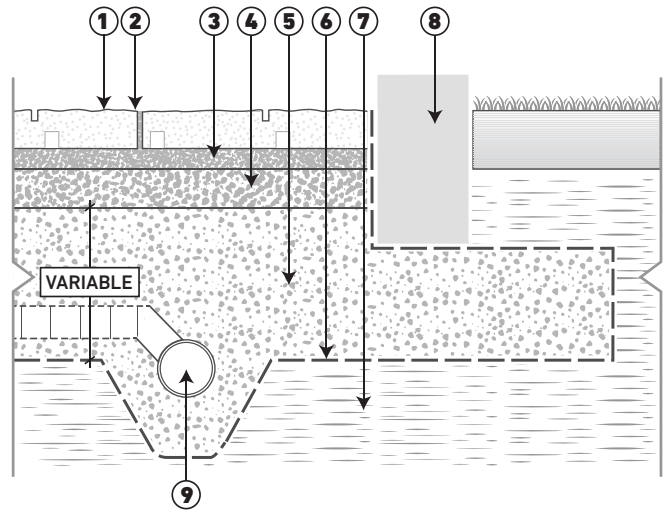

SEGMENTAL PERMEABLE PAVEMENT - NO EXFILTRATION

- 1 Moderna® Permeable Paver by Best Way Stone®
- 2 Joint filling material ASTM No 8 (CSA 2.5-10mm) aggregate
- 3 Bedding course 1 1/5" to 2" (40 to 50 mm) ASTM No 8 (CSA 2.5-10mm) aggregate
- 4 Base course 4" (100mm) ASTM No 57 (CSA 5-28mm) aggregate foundation thickness
- 5 Subbase course ASTM No 2 (CSA 40-80mm) aggregate
- 6 Geotextile
- 7 Subgrade
- 8 Concrete edge
- 9 Perforated drain connected to drainage system
- 10 Impermeable membrane

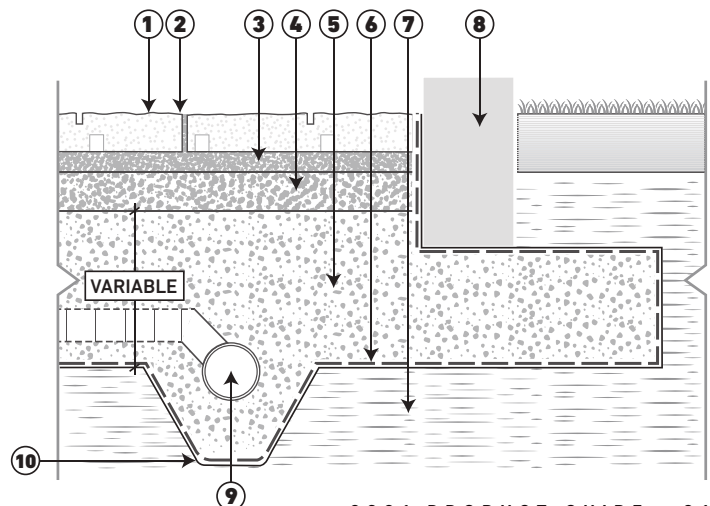

INSTALLATION GUIDES - RETAINING WALLS

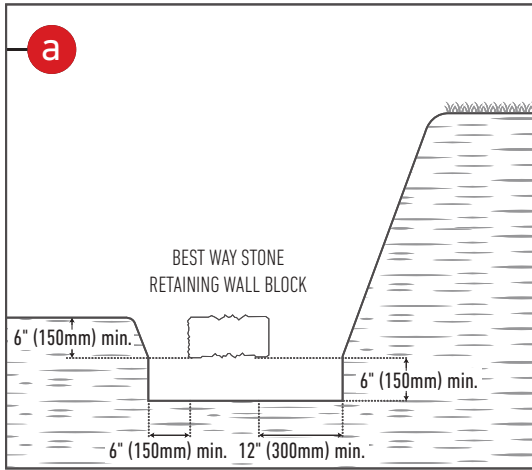

a. EXCAVATE THE AREA

1. Check for existing utilities or structures in the area of construction.
2. Dig a trench. Calculate the width of the area by adding 6" of space before the face of the wall, and 12" behind the wall block.
3. Calculate the depth of the trench by the burial depth of the wall. Consider that good practice is to have at least 10% of the total wall height buried below final grade.

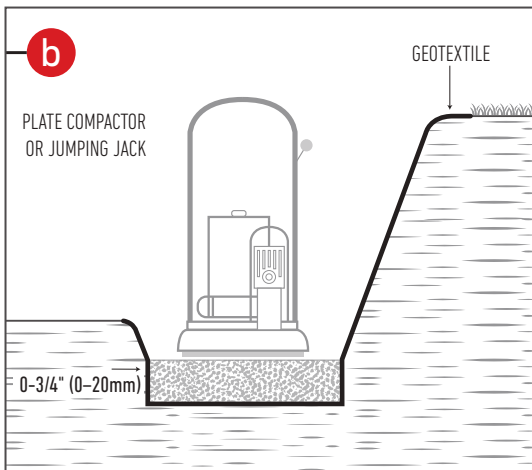

b. PREPARE THE FOUNDATION

1. Cover the back and the base of the trench with geotextile. Extend the geotextile along the back of the excavated area to eventually above the drainage fill once in place at the top of the wall.
2. Spread 0-3/4" (0-20mm) stone in the trench, and compact using a vibrating plate compactor or a jumping jack. Make sure your area remains level after compaction. The compacted area must be at least 6" (150mm) thick. Add more stone if needed and compact again.

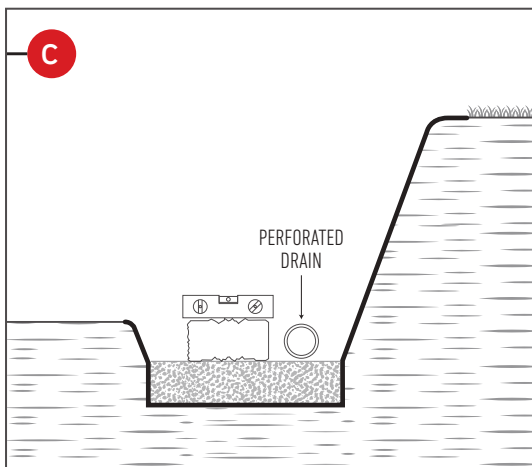

c. CONSTRUCT THE FIRST COURSE

1. Begin placing your first course of the Best Way Stone blocks along your levelled pad. Ensure the alignment and level are consistent.
2. The desired exposed face of the wall must be placed side by side with each block touching the next. There should be no space between block faces of the exposed side of the wall.
3. Add a perforated drain pipe at the back of the wall on top of the levelled stone base. Ensure to connect this pipe to the existing drainage system keeping water from accumulating behind the wall.

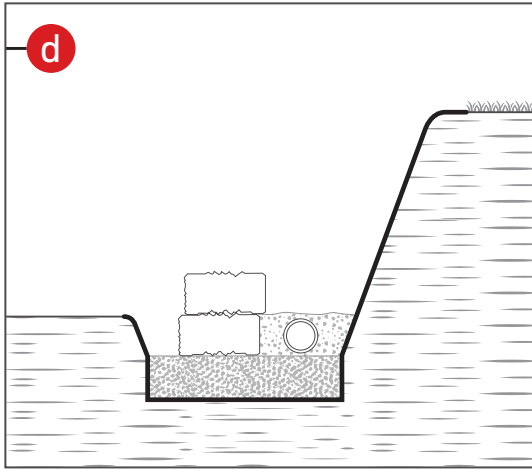

d. ADD THE BACKFILL

1. Add 0-3/4" (0-20mm) clean stone backfill to the rear of the wall, burying the perforated drain pipe. Ensure the geotextile remains along the backside as you backfill all the way up the wall, and does not fall into the backfill material.
2. Level the clean stone before constructing the next course. Ensure to fill all voids in the back of the wall with backfill.

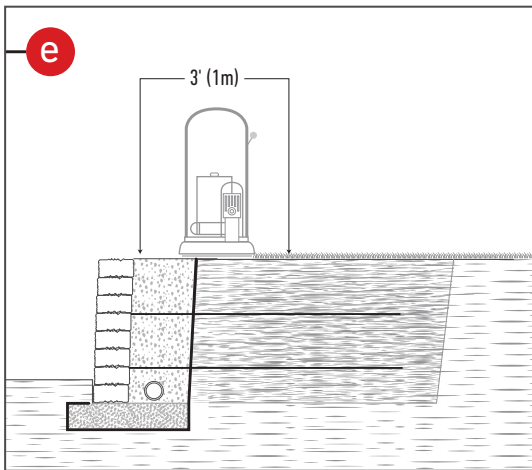

e. THE REMAINING COURSES

1. When constructing the remaining courses ensure to clean off the top of blocks of the previous row. Make sure the blocks are installed with the appropriate side facing up following the locking system.
2. Backfill behind each constructed course with the same clean stone.
3. In order to maximize the strength of the wall, ensure that the joints of the row being constructed do not align with the row directly below or above. The joints of a course should match alternating courses.

Care & Considerations

Setting a base

The quality of work put into establishing a solid foundation is vital to the overall performance of your landscape design.

When properly constructed, a solid base foundation helps prevent paver settling, shifting, and water accumulation. Use of edge restraints and jointing sand is recommended as best practice by ICPI (Interlocking Concrete Pavement Institute).

When choosing and installing jointing sand, please ensure to follow the directions given by the manufacturer. To find out more about base preparation and installation practices, visit www.icpi.org.

Colour distribution

When installing stone, we recommend you select a mix of materials from several different bundles to ensure a balanced distribution of surface colour textures and colour mixtures.

Always verify colours and products chosen for your concrete landscape project with your contractor or landscape designer prior to installation. Physical or printed colour samples are only representations of the chosen product. If you notice a discrepancy, notify us immediately before continuing with your project. Full installation is understood as your acceptance of the product's condition.

Concrete care

Maintaining the surface of your concrete pavers is essential to their aesthetic. Sealing your concrete pavers can enhance the colour, but it's optional as our pavers are just as durable with or without the addition of sealants. If you plan on sealing your concrete products, always follow the manufacturer's instructions for proper application.

Unfortunately, even materials as durable as concrete can scratch, chip, or stain if handled incorrectly. When compacting our pavers, ensure that a rubber membrane is added to protect textured surfaces from potential damage. Use a rubber blade when removing snow from the surface of our pavers to prevent surface scratching and damage. Best Way Stone is not responsible for the damage left by the misuse of compaction or snow removal equipment.

Efflorescence

Efflorescence is that white, powdery substance that appears on the surface of concrete and it's a naturally occurring process. Efflorescence does not affect the structural integrity or strength of the product and will usually wear off over time – although special cleaners can be used to speed up its removal. For more information visit www.icpi.org.

Choosing a Contractor

Although not required, hiring a qualified contractor makes installing stone a much more efficient and less stressful experience. When hiring a qualified professional we recommend they follow industry standard guidelines.

When hiring a contractor, we recommend collecting project references and samples of previous work. Make sure they offer a comprehensive warranty, and have all the required insurance and licenses. Any contractor will understand the industry standards for installing stone – you can download a copy to these guidelines by visiting www.icpi.org.

Where to find our products

Best Way Stone has an extensive network of dealers throughout Ontario, Quebec, and North-East Michigan. Visit our website to find a dealer near you: www.bestwaystone.com/find-a-dealer





Uxbridge Outdoor Design Centre

Speak to our customer service experts to help bring your design to life. Feel free to bring samples home along with some peace of mind.

Outdoor Design Centre

65 Anderson Boulevard
Uxbridge, ON



SAFETY PRECAUTIONS

CAUTION! Product strapping under extreme tensions

Cut straps are sharp and may result in severe physical injury if proper precautions are not taken. Removal and handling of straps must be done with caution while wearing necessary protective equipment (Gloves, Goggles, Safety Boots, and Protective Clothing).

Concrete Materials must be cut in well-ventilated areas only. Use of a "Wet-Cut" Saw or other similar method is recommended to reduce hazardous dust production. Approved respirators, safety goggles, hearing protection, and gloves should be worn at all times.

Bundled material must always be transported and stored using appropriate equipment, meeting the regulations of local legislation (Transportation tie-down, vehicle weight limitations, and public storage location). Stacking more than two bundles on top of each other is not recommended.

Best Way Stone Limited® assumes no liability or responsibility for loss or damage resulting from the improper use or handling of our products, or from failure to follow instructions, warnings, and/or advisories on the product label and on the MSDS Precast Concrete Sheet (available upon request).

BEFORE OPENING ANY PRODUCTS:

Please check for correct colour and product (shape/size/design). Opening of this package (removal of strapping and/or shrink wrapping) assumes full acceptance of product by the purchaser. Material may not be returned or exchanged once the original packaging has been removed.

All concrete products may have significant colour variance between production lots. It is recommended that installation occur from multiple bundles simultaneously to ensure proper colour variance blending for both colour mixes and solid colours. In the case of a single-bundle installation, material should be installed from opposite ends of the bundle simultaneously.

Defective material delivered to the purchaser over the accepted norm will be replaced. (Please Note: Chipped and Cracked products are often used in areas where cutting is required. As such, please remove chipped or cracked products for this purpose). The purchaser must inform the manufacturer in writing within five days of delivery. Any materials in question must be available for inspection by Best Way Stone® before any credit or adjustment can be made.

PLEASE NOTE: If materials are completely or partially installed, they will be deemed acceptable and there will be no exceptions made for defective or unsatisfactory material.

OUR LOCATIONS

WOODBIDGE

8821 Weston Road
Woodbridge, ON L4L 0K9

1-800-BESTWAY (2378929)

T (905) 851-5122

T (416) 747-0988

F (905) 851-7603



UXBRIDGE

65 Anderson Boulevard
Uxbridge, ON L9P 0C7

T (905) 640-5845

F (905) 640-9773







2021 PRODUCT GUIDE

Connect with us @bestwaystone



1-800-BESTWAY (237-8929)

BESTWAYSTONE.COM

WOODBIDGE (HEAD OFFICE)

8821 Weston Road
Woodbridge, ON L4L 0K9
T 416-747-0988
F 905-851-7603

UXBRIDGE

65 Anderson Boulevard
Uxbridge, ON L9P 0C7
T 905-640-5845
F 905-640-9773